



Zastosowanie

Wentylatory dachowe wyciągowe z wyrzutem pionowym, przeznaczone są do systemów wentylacyjnych budynków o niskim stopniu zanieczyszczenia powietrza. Przeznaczone do pracy ciągłej.

Stosowane są między innymi w instalacjach wyciągowych:

- z budynków mieszkalnych, supermarketów,
- hal przemysłowych, warsztatów, magazynów, toalet,
- garaży, parkingów, budynków gospodarczych i innych.

Konstrukcja

- wirnik z łopatkami pochylonymi do tyłu, wykonany z tworzywa sztucznego lub blachy stalowej ocynkowanej (w zależności od modelu),
- podstawa wykonana z blachy aluminiowej,
- obudowa wykonana z blachy aluminiowej,
- przystosowany do pracy w pozycji pionowej,
- montaż na dachach płaskich,
- temperatura pracy od -40°C do $+80^{\circ}\text{C}$, w zależności od modelu,
- RFV EIS – wersja z wyłącznikiem serwisowym.

Silnik elektryczny

- asynchroniczny, jednofazowy, 230V, 50Hz, silnik indukcyjny z zewnętrznym wirnikiem,
- asynchroniczny, trójfazowy, 400V, 50Hz, silnik indukcyjny z zewnętrznym wirnikiem,
- przystosowany do płynnej regulacji prędkości obrotowej,
- termiczne zabezpieczenie przed przeciążeniem,
- klasa izolacji B (modele od RFV/x125 do RFV/x250, bez RFV/2-160S/H),
- klasa izolacji F (modele RFV/2-160S/H i od RFV/x-315 do RFV/x-630),
- stopień ochrony IP44 (modele od RFV/x125 do RFV/x250 bez RFV/2-160S/H),
- stopień ochrony IP54 (modele RFV/2-160S/H i od RFV/x-315 do RFV/x-630).

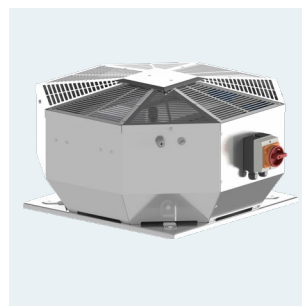
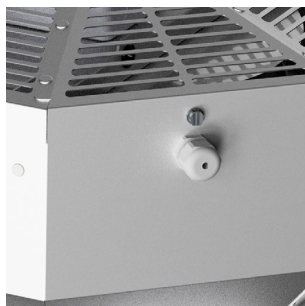
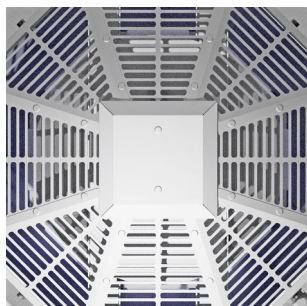
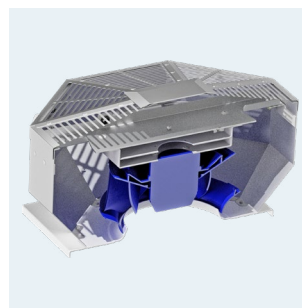
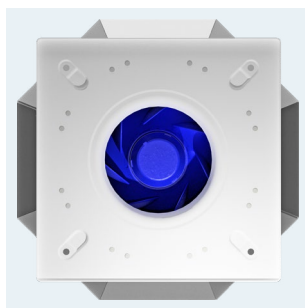

Siatka ochronna

Przepust kablowy

RFV EIS - wersja z wyłącznikiem serwisowym

POWIĄZANE PRODUKTY





DANE TECHNICZNE

model wentylatora	wydajność max	ciśnienie max	prędkość obrotowa	napięcie nominalne	natężenie znam.**	pobór mocy max	poziom ciśnienia akust.*	temp. pracy min / max	masa jednostki	numer artykułu	numer artykułu z wyłącznikiem serwis.
RFV/2-125S	450 m ³ /h	354 Pa	2 640 rpm	1-230 V	0,35 A	75 W	60 dB(A)	-40 / 70 °C	3,5 kg	43528210	43528210-11
RFV/4-125S	250 m ³ /h	90 Pa	1 430 rpm	1-230 V	0,16 A	34 W	49 dB(A)	-40 / 60 °C	3,5 kg	43528215	43528215-11
RFV/2-160S/L	720 m ³ /h	400 Pa	2 700 rpm	1-230 V	0,43 A	85 W	64 dB(A)	-40 / 65 °C	4,0 kg	43528230	43528230-11
RFV/2-160S/H	850 m ³ /h	520 Pa	2 500 rpm	1-230 V	0,52 A	120 W	66 dB(A)	-40 / 60 °C	4,4 kg	43528232	43528232-11
RFV/4-160S	460 m ³ /h	142 Pa	1 430 rpm	1-230 V	0,21 A	40 W	52 dB(A)	-40 / 60 °C	4,0 kg	43528235	43528235-11
RFV/2-200S	1 400 m ³ /h	680 Pa	2 750 rpm	1-230 V	1,3 A	303 W	70 dB(A)	-40 / 65 °C	6,5 kg	43528245	43528245-11
RFV/4-200S	1 000 m ³ /h	190 Pa	1 400 rpm	1-230 V	0,4 A	90 W	56 dB(A)	-40 / 55 °C	6,0 kg	43528250	43528250-11
RFV/4-250S	1 450 m ³ /h	188 Pa	1 310 rpm	1-230 V	0,66 A	150 W	58 dB(A)	-40 / 65 °C	8,0 kg	43528260	43528260-11
RFV/4-250T	1 400 m ³ /h	288 Pa	1 400 rpm	3-400 V	0,28 A	100 W	61 dB(A)	-40 / 60 °C	8,5 kg	43528280	43528280-11
RFV/6-250S	850 m ³ /h	115 Pa	965 rpm	1-230 V	0,18 A	37 W	53 dB(A)	-40 / 60 °C	8,0 kg	43528265	43528265-11
RFV/4-315S	2 200 m ³ /h	250 Pa	1 390 rpm	1-230 V	1,63 A	270 W	60 dB(A)	-40 / 60 °C	10,0 kg	43528270	43528270-11
RFV/4-315T	3 000 m ³ /h	320 Pa	1 340 rpm	3-400 V	0,68 A	240 W	61 dB(A)	-40 / 60 °C	11,0 kg	43528290	43528290-11
RFV/6-315S	1 450 m ³ /h	145 Pa	950 rpm	1-230 V	0,33 A	70 W	54 dB(A)	-40 / 60 °C	10,0 kg	43528275	43528275-11
RFV/4-355S	3 500 m ³ /h	415 Pa	1 398 rpm	1-230 V	2,3 A	540 W	68 dB(A)	-40 / 60 °C	21,0 kg	43528300	43528300-11
RFV/4-355T Δ	3 500 m ³ /h	418 Pa	1 352 rpm	3-400 V	1,0 A	440 W	67 dB(A)	-40 / 60 °C	21,0 kg	43528305	43528305-11
RFV/4-355T Y	3 050 m ³ /h	310 Pa	1 106 rpm	3-400 V	0,54 A	310 W	67 dB(A)	-40 / 60 °C	21,0 kg	43528305	43528305-11
RFV/6-355T Δ	2 300 m ³ /h	185 Pa	962 rpm	3-400 V	0,47 A	180 W	60 dB(A)	-40 / 70 °C	20,0 kg	43528315	43528315-11
RFV/6-355T Y	2 050 m ³ /h	145 Pa	807 rpm	3-400 V	0,2 A	110 W	56 dB(A)	-40 / 70 °C	20,0 kg	43528315	43528315-11
RFV/4-400S	4 800 m ³ /h	350 Pa	1 270 rpm	1-230 V	2,6 A	580 W	72 dB(A)	-40 / 60 °C	24,0 kg	43528320	43528320-11
RFV/4-400T Δ	4 800 m ³ /h	470 Pa	1 408 rpm	3-400 V	1,3 A	640 W	71 dB(A)	-40 / 70 °C	23,0 kg	43528325	43528325-11
RFV/4-400T Y	4 150 m ³ /h	390 Pa	1 140 rpm	3-400 V	0,8 A	460 W	68 dB(A)	-40 / 70 °C	23,0 kg	43528325	43528325-11
RFV/6-400S	2 650 m ³ /h	186 Pa	931 rpm	1-230 V	0,7 A	180 W	62 dB(A)	-40 / 70 °C	23,0 kg	43528330	43528330-11
RFV/6-400T Δ	3 680 m ³ /h	260 Pa	952 rpm	3-400 V	0,59 A	270 W	61 dB(A)	-40 / 70 °C	22,0 kg	43528335	43528335-11
RFV/6-400T Y	3 050 m ³ /h	170 Pa	690 rpm	3-400 V	0,3 A	165 W	61 dB(A)	-40 / 70 °C	22,0 kg	43528335	43528335-11
RFV/4-450S	7 470 m ³ /h	680 Pa	1 390 rpm	1-230 V	5,3 A	1 270 W	72 dB(A)	-40 / 60 °C	37,0 kg	43528340	43528340-11
RFV/4-450T/L Δ	6 580 m ³ /h	605 Pa	1 388 rpm	3-400 V	2,0 A	1 020 W	75 dB(A)	-40 / 70 °C	34,0 kg	43528345	43528345-11
RFV/4-450T/L Y	5 570 m ³ /h	490 Pa	982 rpm	3-400 V	1,2 A	700 W	71 dB(A)	-40 / 70 °C	34,0 kg	43528345	43528345-11
RFV/4-450T/H	7 200 m ³ /h	430 Pa	1 370 rpm	3-400 V	3,4 A	1 000 W	75 dB(A)	-40 / 60 °C	31,0 kg	43528350	43528350-11
RFV/6-450T Δ	4 500 m ³ /h	270 Pa	912 rpm	3-400 V	0,8 A	410 W	63 dB(A)	-40 / 80 °C	27,0 kg	43528355	43528355-11
RFV/6-450T Y	3 450 m ³ /h	185 Pa	660 rpm	3-400 V	0,4 A	225 W	58 dB(A)	-40 / 80 °C	27,0 kg	43528355	43528355-11
RFV/4-500T/L	7 600 m ³ /h	680 Pa	1 360 rpm	3-400 V	2,8 A	1 250 W	73 dB(A)	-40 / 60 °C	46,0 kg	43528370	43528370-11
RFV/6-500S/L	5 700 m ³ /h	325 Pa	925 rpm	1-230 V	2,2 A	490 W	67 dB(A)	-40 / 60 °C	39,0 kg	43528372	43528372-11
RFV/6-500S/H	6 500 m ³ /h	220 Pa	900 rpm	1-230 V	2,5 A	540 W	65 dB(A)	-40 / 60 °C	43,0 kg	43528373	43528373-11
RFV/6-500T	5 050 m ³ /h	285 Pa	920 rpm	3-400 V	0,8 A	390 W	64 dB(A)	-40 / 60 °C	39,0 kg	43528375	43528375-11
RFV/4-560T/L Δ	12 200 m ³ /h	880 Pa	1 364 rpm	3-400 V	4,9 A	2 770 W	74 dB(A)	-40 / 40 °C	58,0 kg	43528380	43528380-11
RFV/4-560T/L Y	8 500 m ³ /h	720 Pa	975 rpm	3-400 V	2,74 A	1 540 W	65 dB(A)	-40 / 40 °C	58,0 kg	43528380	43528380-11
RFV/4-560T/H	13 000 m ³ /h	640 Pa	1 333 rpm	3-400 V	4,6 A	2 513 W	74 dB(A)	-40 / 45 °C	55,0 kg	43528381	43528381-11
RFV/6-560S	8 800 m ³ /h	285 Pa	890 rpm	1-230 V	4,2 A	840 W	66 dB(A)	-40 / 60 °C	51,0 kg	43528382	43528382-11
RFV/6-560T Δ	8 800 m ³ /h	400 Pa	966 rpm	3-400 V	1,9 A	910 W	68 dB(A)	-40 / 70 °C	51,0 kg	43528385	43528385-11
RFV/6-560T Y	7 500 m ³ /h	370 Pa	743 rpm	3-400 V	1,0 A	570 W	62 dB(A)	-40 / 70 °C	51,0 kg	43528385	43528385-11
RFV/4-630T	18 000 m ³ /h	770 Pa	1 270 rpm	3-400 V	6,6 A	3 900 W	70 dB(A)	-15 / 55 °C	71,0 kg	43528395	43528395-11

*pomiar wykonany w odległości 1,5m od wylotu, dla 0 = 2/3*0max

** wartość prądu znamionowego może się różnić w zależności od producenta zastosowanego silnika elektrycznego.



CHARAKTERYSTYKI PRACY WENTYLATORÓW - SILNIKI 2-BIEGUNOWE

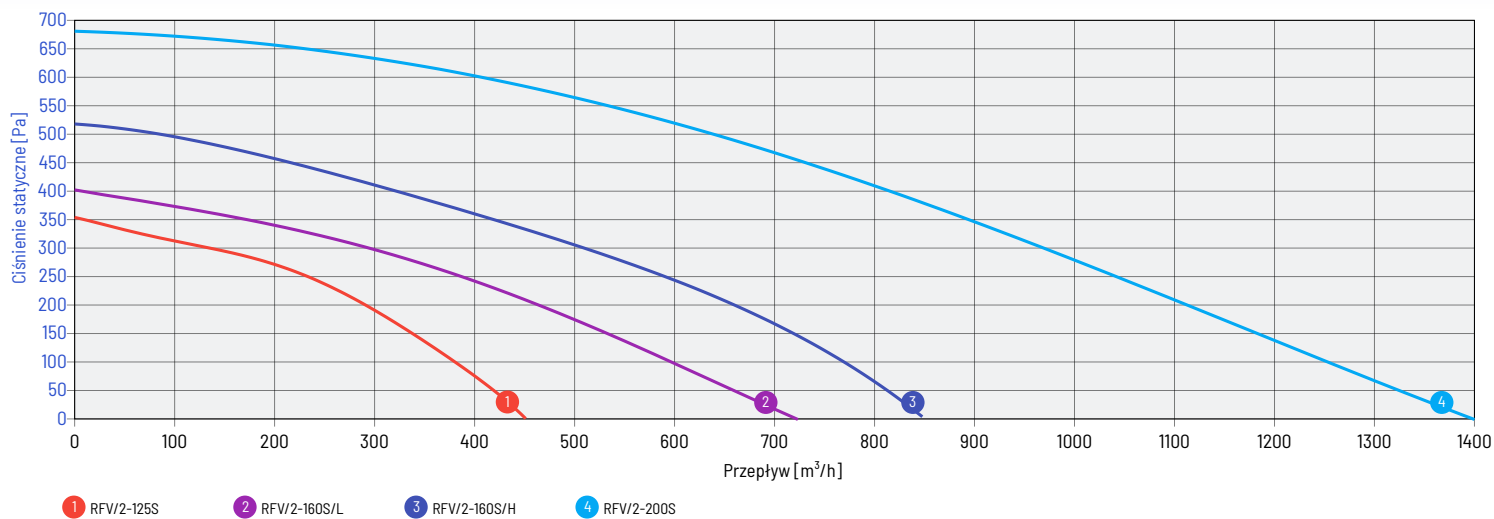

CHARAKTERYSTYKI PRACY WENTYLATORÓW - SILNIKI 4-BIEGUNOWE

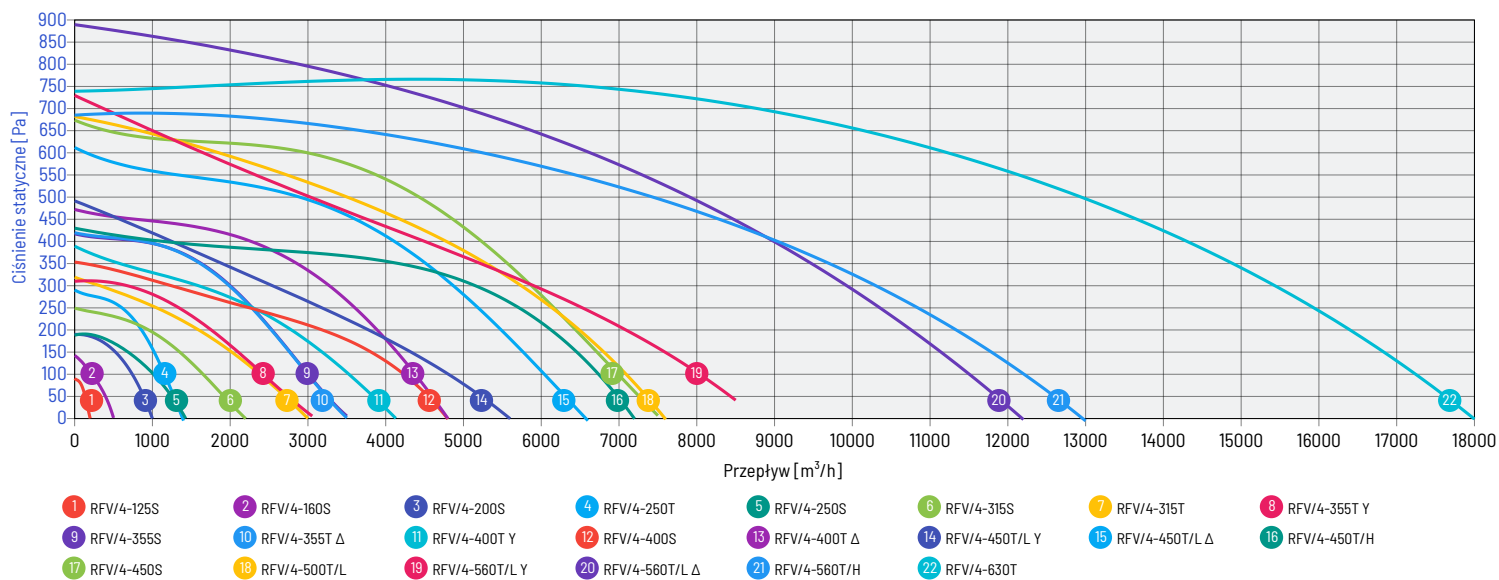

CHARAKTERYSTYKI PRACY WENTYLATORÓW - SILNIKI 6-BIEGUNOWE

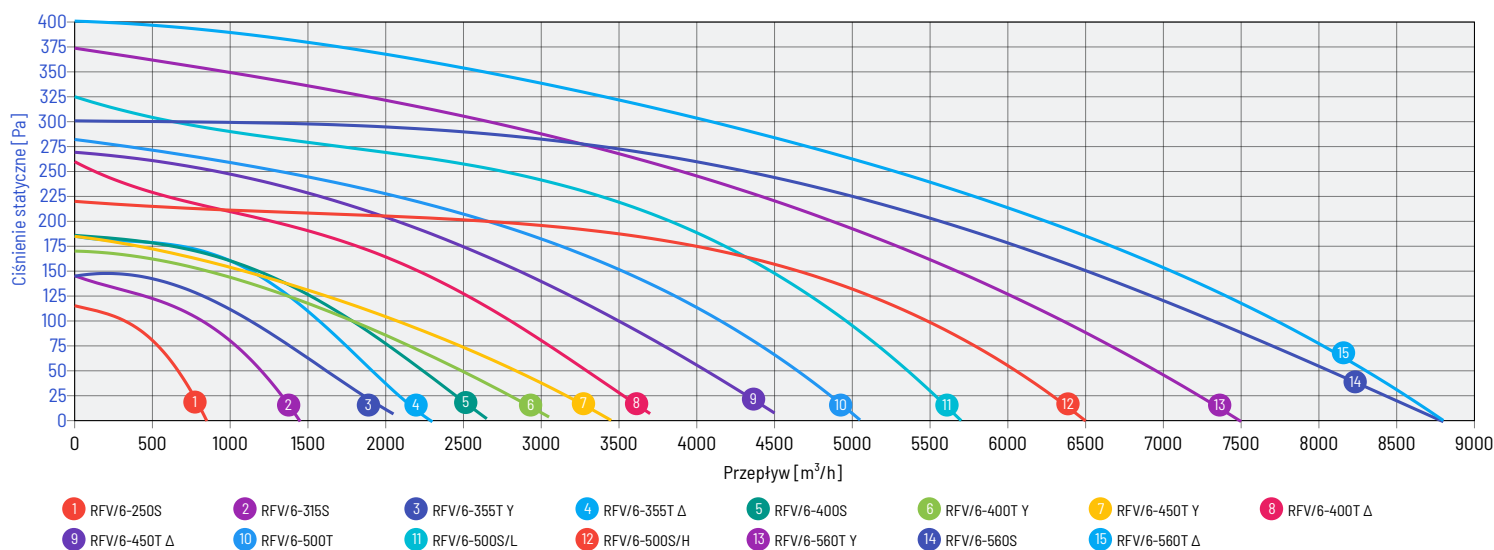



CHARAKTERYSTYKI PRACY WENTYLATORÓW

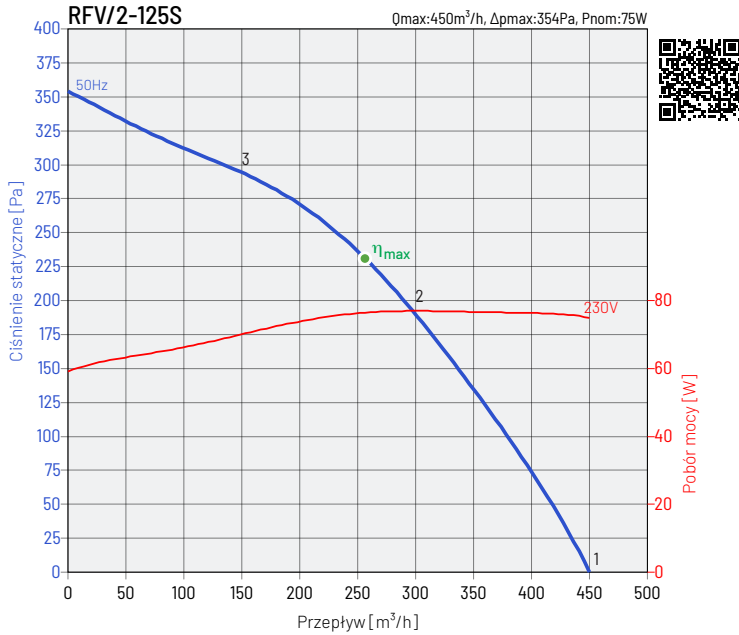

punkt pracy	63 Hz	125 Hz	250 Hz	500 Hz	1000 Hz	2000 Hz	4000 Hz	8000 Hz	L_{WA}	
1	wlot	45	51	62	66	68	64	69	61	74
	wylot	39	43	53	61	64	67	65	51	71
2	wlot	42	47	61	64	67	66	54	39	71
	wylot	37	39	52	58	60	62	58	45	66
3	wlot	38	44	58	61	63	59	61	49	68
	wylot	36	39	55	63	61	60	57	43	67

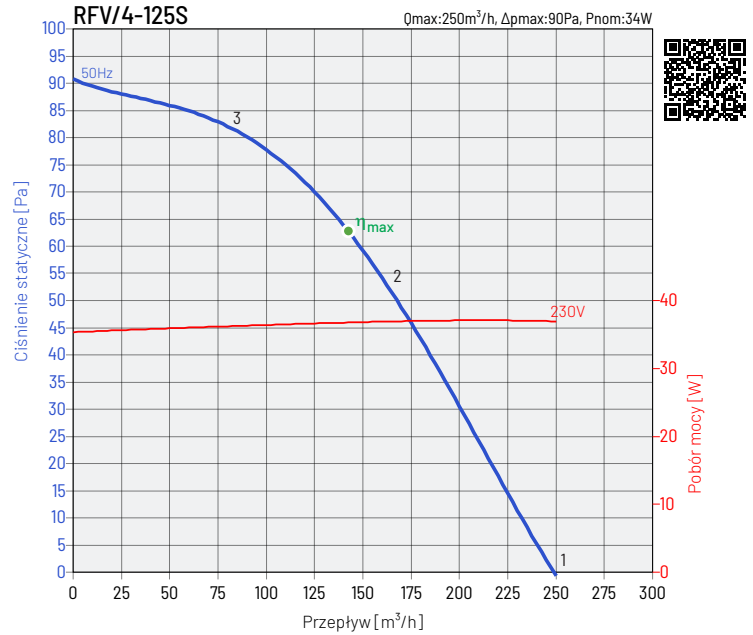

punkt pracy	63 Hz	125 Hz	250 Hz	500 Hz	1000 Hz	2000 Hz	4000 Hz	8000 Hz	L_{WA}	
1	wlot	32	40	51	53	54	55	46	33	60
	wylot	28	32	40	45	47	51	39	25	54
2	wlot	31	39	50	52	54	55	45	32	59
	wylot	27	30	39	42	45	42	34	19	49
3	wlot	28	37	49	51	53	53	41	28	58
	wylot	28	33	41	42	45	41	34	17	49

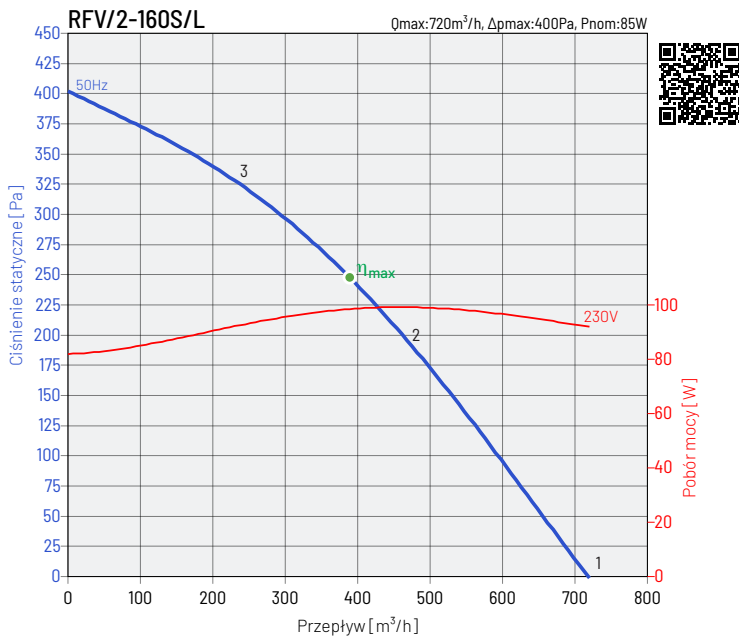

punkt pracy	63 Hz	125 Hz	250 Hz	500 Hz	1000 Hz	2000 Hz	4000 Hz	8000 Hz	L_{WA}	
1	wlot	48	50	63	67	70	65	69	48	75
	wylot	35	48	57	66	68	69	65	56	73
2	wlot	44	48	62	65	68	64	62	47	72
	wylot	35	47	56	62	64	64	56	49	69
3	wlot	40	45	61	63	64	62	60	51	69
	wylot	33	51	59	61	63	64	61	45	69

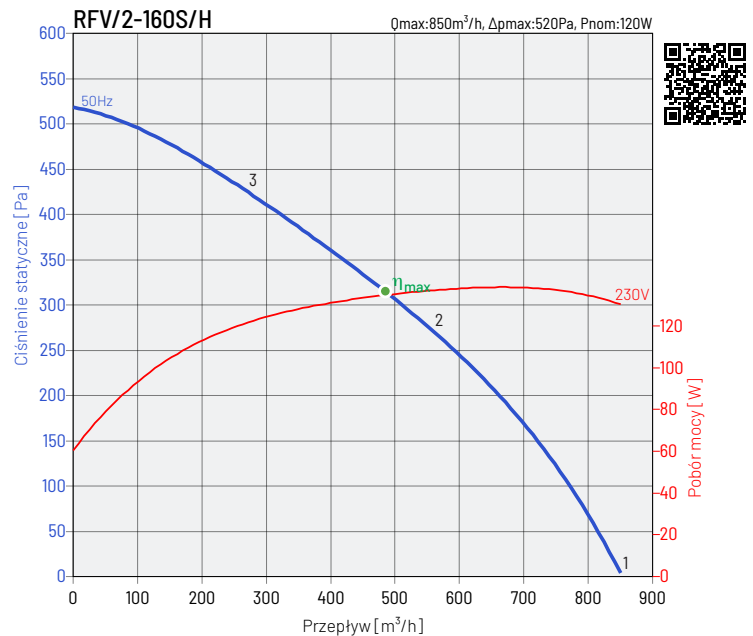

punkt pracy	63 Hz	125 Hz	250 Hz	500 Hz	1000 Hz	2000 Hz	4000 Hz	8000 Hz	L_{WA}	
1	wlot	50	52	64	69	72	67	68	50	76
	wylot	34	43	59	60	65	66	65	55	71
2	wlot	48	49	63	68	69	66	63	49	74
	wylot	35	41	57	56	60	60	56	49	65
3	wlot	46	47	61	64	65	64	59	47	70
	wylot	32	51	56	58	61	60	56	45	66



CHARAKTERYSTYKI PRACY WENTYLATORÓW

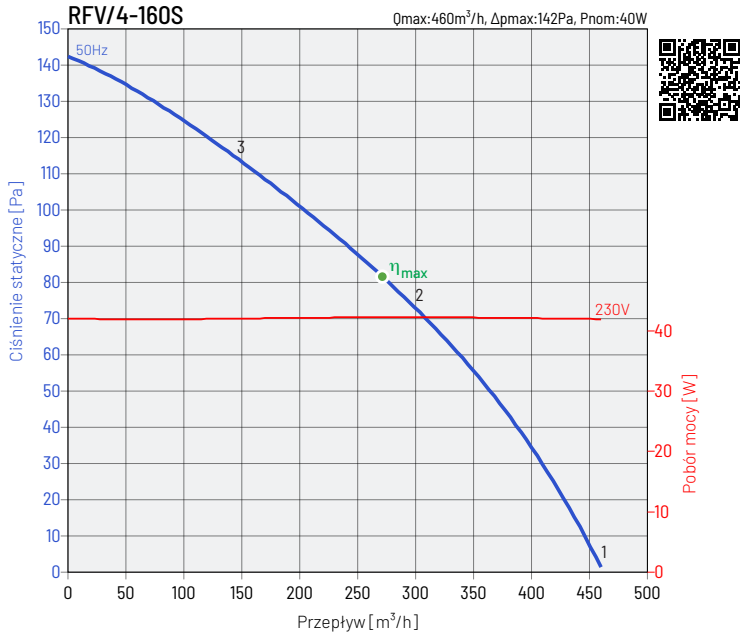

punkt pracy		63 Hz	125 Hz	250 Hz	500 Hz	1000 Hz	2000 Hz	4000 Hz	8000 Hz	L_{WA}
1	wlot	31	47	47	51	57	55	60	37	63
	wylot	28	33	47	53	59	60	58	46	64
2	wlot	31	46	46	46	54	49	50	32	57
	wylot	27	30	45	51	55	57	55	42	61
3	wlot	37	47	49	48	50	46	39	28	55
	wylot	26	32	43	49	54	55	52	37	59

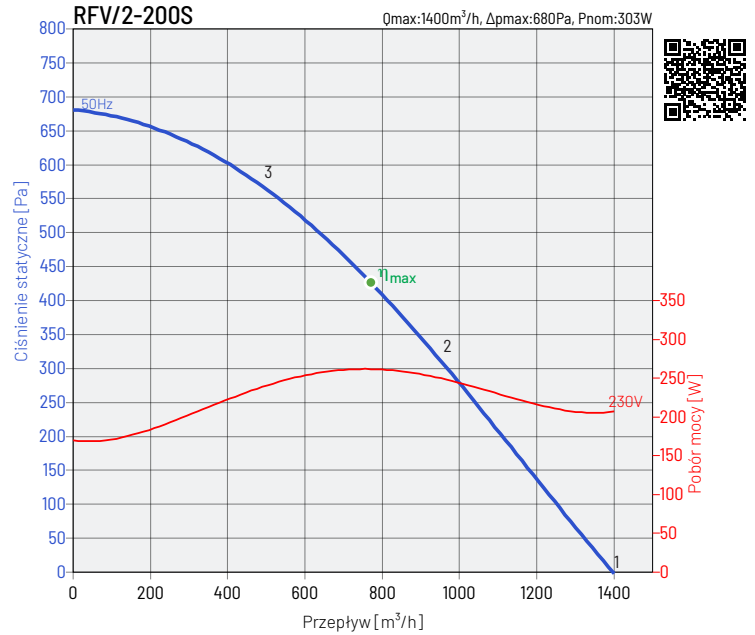

punkt pracy		63 Hz	125 Hz	250 Hz	500 Hz	1000 Hz	2000 Hz	4000 Hz	8000 Hz	L_{WA}
1	wlot	42	62	67	75	76	76	74	71	82
	wylot	37	46	71	70	72	72	68	64	78
2	wlot	44	59	68	74	73	69	68	62	78
	wylot	36	51	65	67	68	66	63	55	73
3	wlot	49	66	71	77	74	70	68	61	80
	wylot	36	51	65	67	68	66	63	55	73

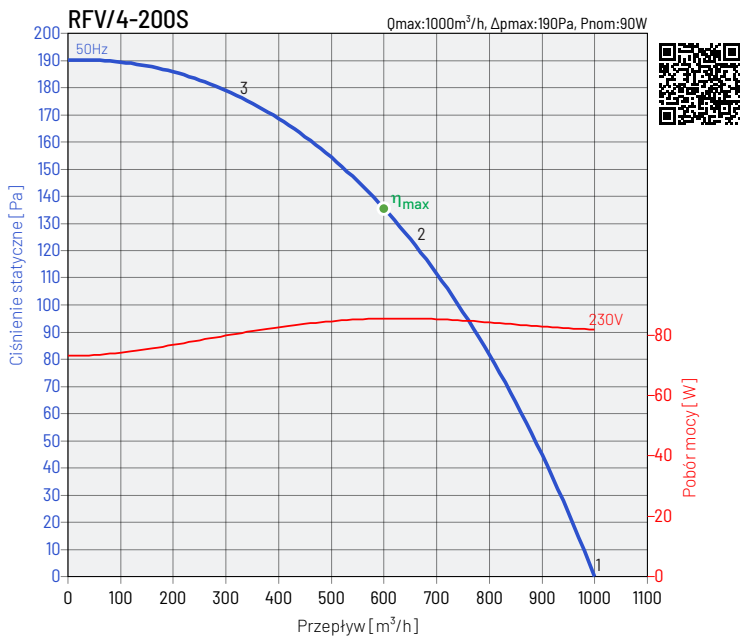

punkt pracy		63 Hz	125 Hz	250 Hz	500 Hz	1000 Hz	2000 Hz	4000 Hz	8000 Hz	L_{WA}
1	wlot	32	49	49	52	59	56	63	40	65
	wylot	38	46	55	58	61	62	57	45	66
2	wlot	32	47	47	49	50	52	54	45	59
	wylot	38	45	55	58	58	58	51	40	64
3	wlot	38	47	48	50	52	50	41	30	57
	wylot	37	47	48	52	55	55	49	36	60

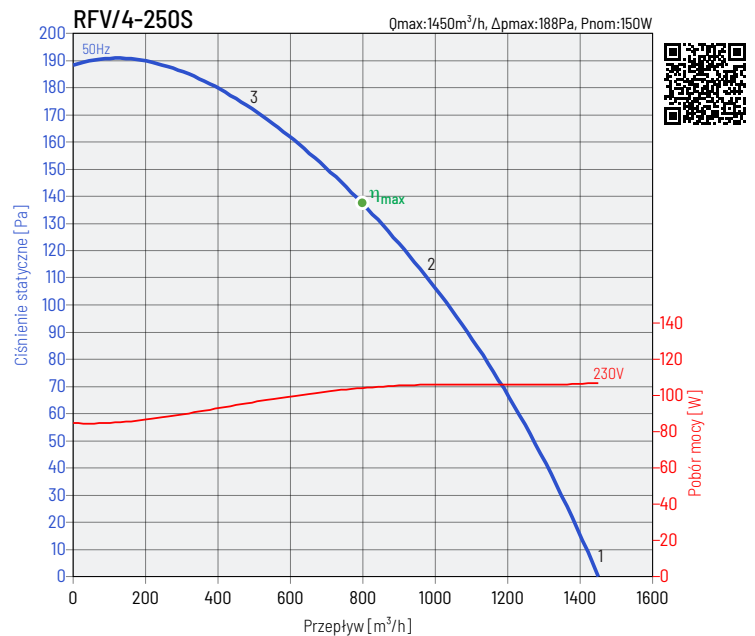

punkt pracy		63 Hz	125 Hz	250 Hz	500 Hz	1000 Hz	2000 Hz	4000 Hz	8000 Hz	L_{WA}
1	wlot	35	50	52	52	63	60	61	51	67
	wylot	45	51	58	60	61	59	57	46	66
2	wlot	35	49	49	51	62	58	57	49	65
	wylot	42	49	54	56	56	54	49	36	62
3	wlot	33	48	48	51	61	57	57	47	64
	wylot	41	47	49	53	53	51	46	33	59



CHARAKTERYSTYKI PRACY WENTYLATORÓW

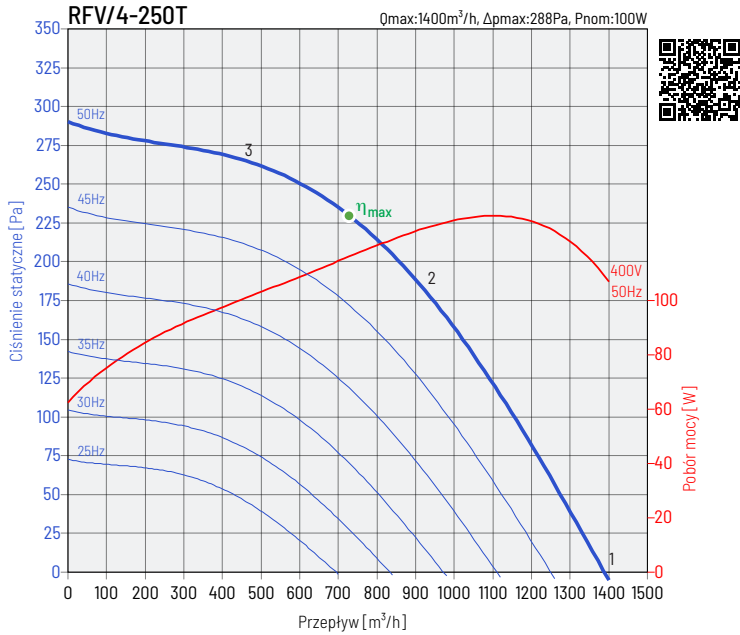

punkt pracy	63 Hz	125 Hz	250 Hz	500 Hz	1000 Hz	2000 Hz	4000 Hz	8000 Hz	L_{WA}	
1	wlot	35	50	53	58	64	62	64	51	69
	wylot	44	54	59	61	62	57	57	40	67
2	wlot	34	50	51	56	63	61	62	50	67
	wylot	40	50	54	57	58	53	49	35	62
3	wlot	34	49	50	54	62	60	61	49	66
	wylot	40	50	52	56	57	53	48	35	62

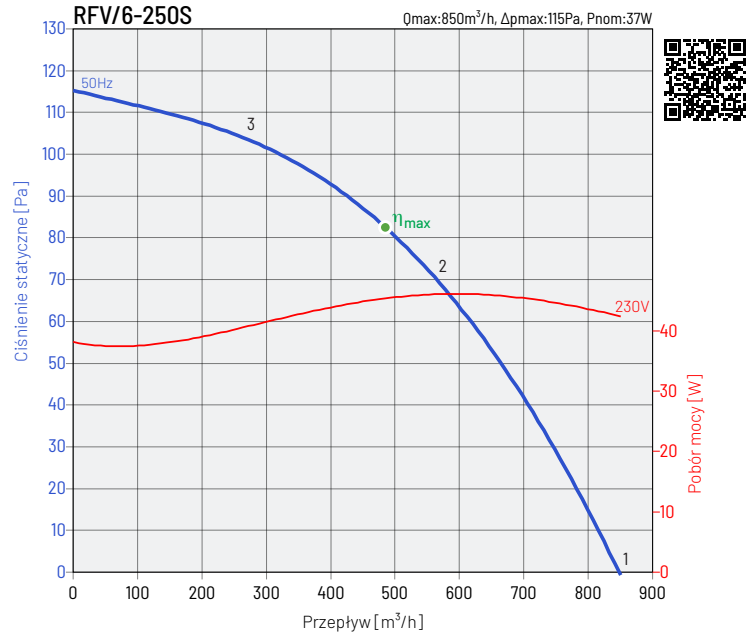

punkt pracy	63 Hz	125 Hz	250 Hz	500 Hz	1000 Hz	2000 Hz	4000 Hz	8000 Hz	L_{WA}	
1	wlot	35	48	48	52	56	55	59	38	63
	wylot	33	43	49	50	50	49	37	26	56
2	wlot	35	47	48	51	54	50	53	37	59
	wylot	32	39	44	48	48	43	33	21	53
3	wlot	35	46	47	51	52	47	49	36	57
	wylot	31	39	42	46	47	42	32	21	51

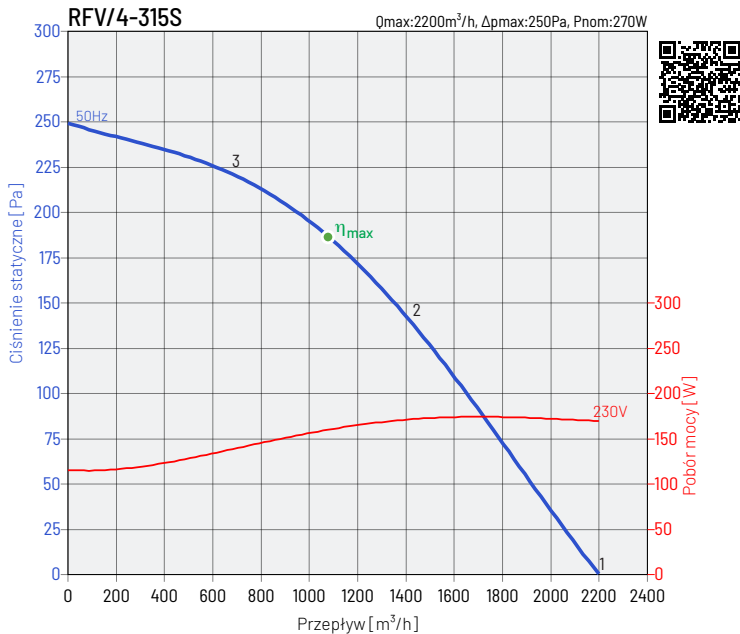

punkt pracy	63 Hz	125 Hz	250 Hz	500 Hz	1000 Hz	2000 Hz	4000 Hz	8000 Hz	L_{WA}	
1	wlot	45	58	60	63	67	66	67	57	73
	wylot	46	54	60	60	64	61	60	50	69
2	wlot	44	54	55	61	66	65	65	55	71
	wylot	45	52	57	58	62	59	56	45	66
3	wlot	45	52	54	60	64	64	63	53	69
	wylot	45	50	53	56	59	57	52	42	63

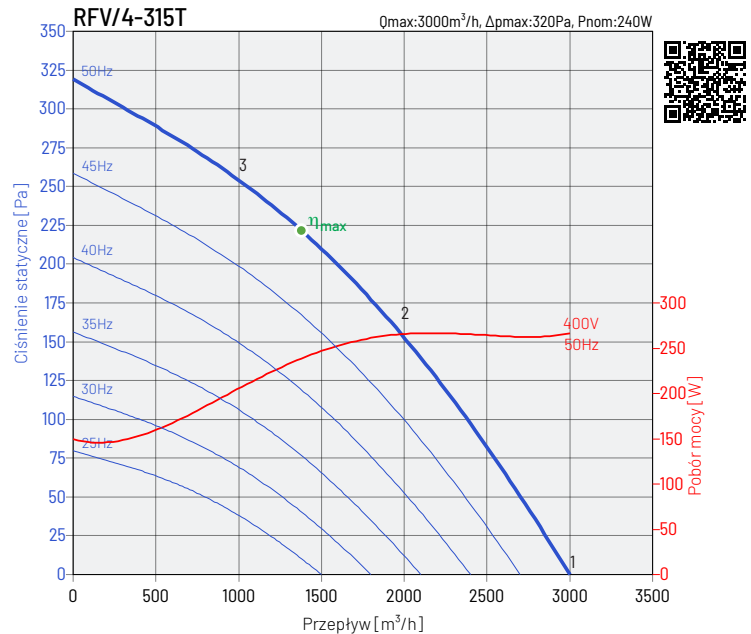

punkt pracy	63 Hz	125 Hz	250 Hz	500 Hz	1000 Hz	2000 Hz	4000 Hz	8000 Hz	L_{WA}	
1	wlot	45	58	60	63	68	66	69	59	74
	wylot	47	56	62	63	66	62	59	49	70
2	wlot	45	54	55	61	66	65	67	58	72
	wylot	45	54	59	62	65	61	57	46	69
3	wlot	44	52	55	60	63	64	64	56	70
	wylot	42	52	55	59	62	59	53	42	66



CHARAKTERYSTYKI PRACY WENTYLATORÓW

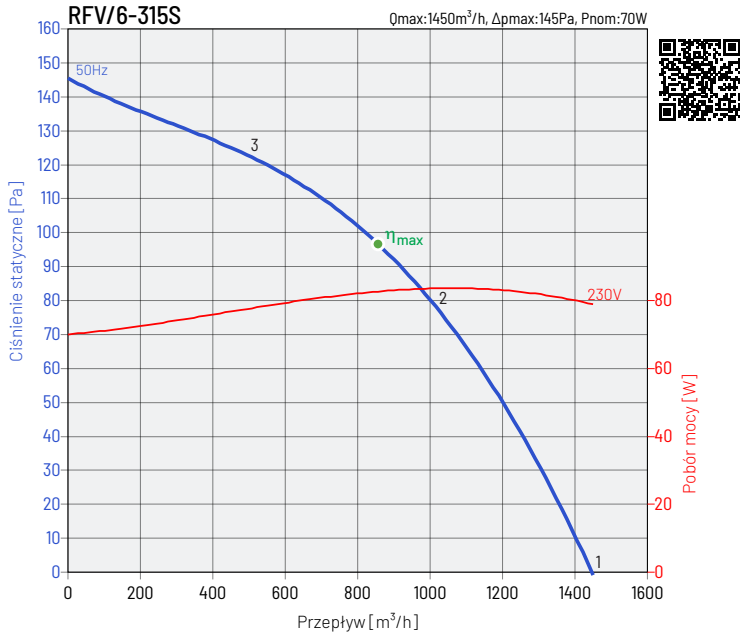

punkt pracy	63 Hz	125 Hz	250 Hz	500 Hz	1000 Hz	2000 Hz	4000 Hz	8000 Hz	L _{wa}	
1	wlot	35	48	50	53	57	56	60	50	64
	wylot	38	46	50	52	52	49	43	27	58
2	wlot	35	44	45	51	56	54	55	48	61
	wylot	36	42	47	51	51	48	44	27	56
3	wlot	34	42	45	50	54	53	54	45	59
	wylot	35	43	45	49	51	47	40	25	55

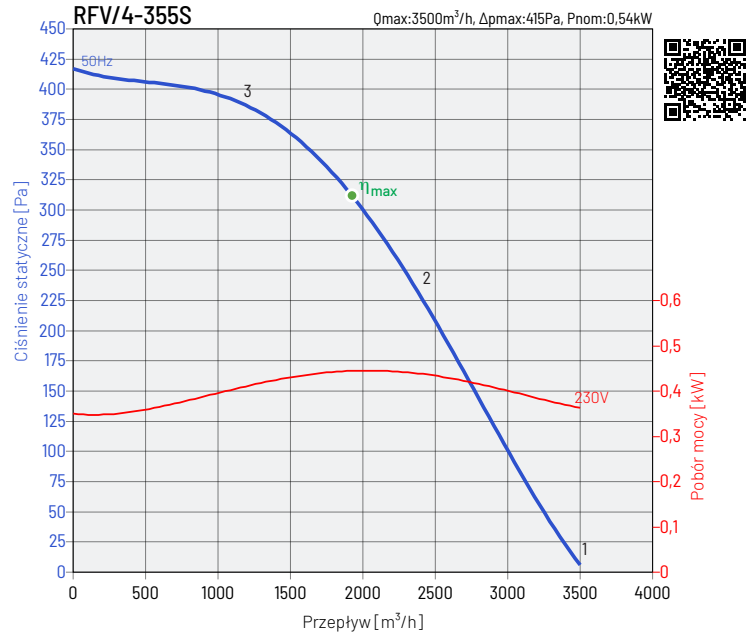

punkt pracy	63 Hz	125 Hz	250 Hz	500 Hz	1000 Hz	2000 Hz	4000 Hz	8000 Hz	L _{wa}	
1	wlot	44	63	67	72	69	67	78	71	80
	wylot	54	63	67	70	71	67	68	52	76
2	wlot	45	60	64	69	66	64	74	66	77
	wylot	55	61	65	68	68	66	63	50	74
3	wlot	42	55	60	63	62	62	68	63	72
	wylot	53	59	62	65	65	63	60	47	71

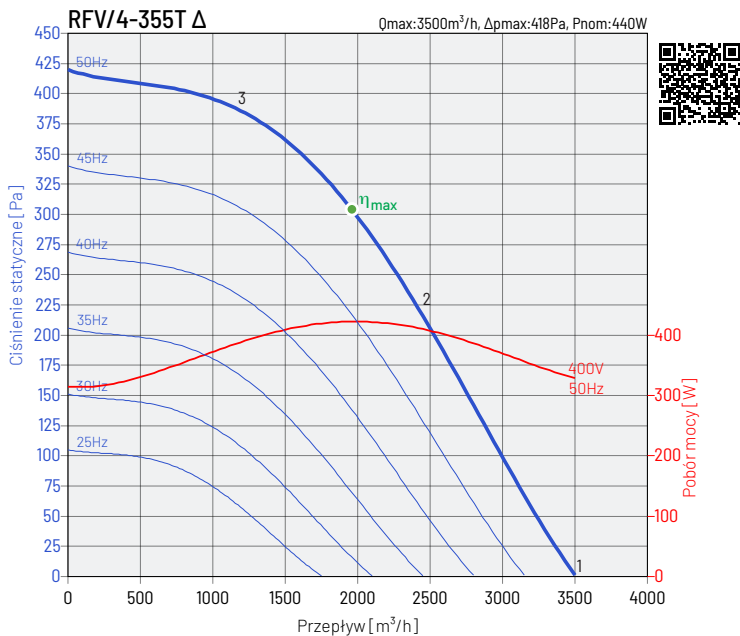

punkt pracy	63 Hz	125 Hz	250 Hz	500 Hz	1000 Hz	2000 Hz	4000 Hz	8000 Hz	L _{wa}	
1	wlot	44	63	67	72	69	67	78	71	80
	wylot	54	63	67	70	69	67	68	52	76
2	wlot	45	60	64	69	66	64	74	66	77
	wylot	55	60	65	68	67	64	61	49	73
3	wlot	42	55	60	63	62	62	68	63	72
	wylot	53	59	62	65	65	63	60	47	71

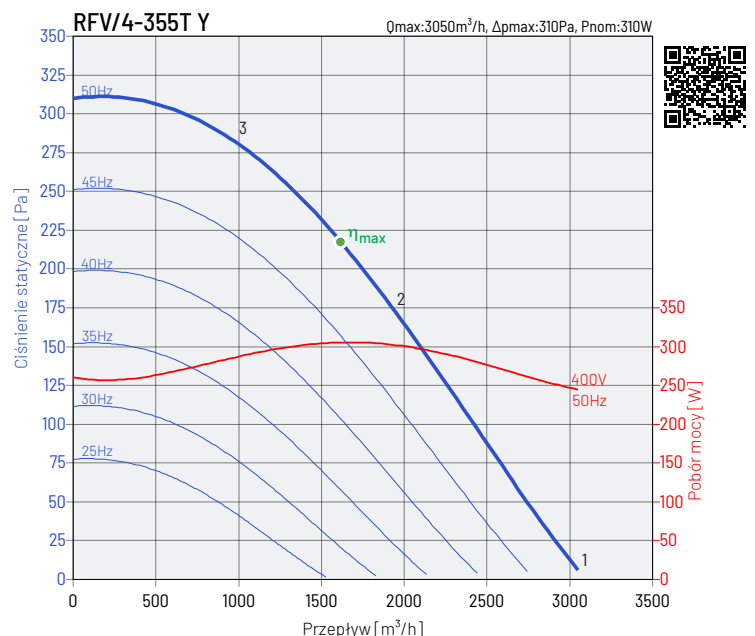

punkt pracy	63 Hz	125 Hz	250 Hz	500 Hz	1000 Hz	2000 Hz	4000 Hz	8000 Hz	L _{wa}
1	wlot								
	wylot								
2	wlot								
	wylot								
3	wlot								
	wylot								



CHARAKTERYSTYKI PRACY WENTYLATORÓW

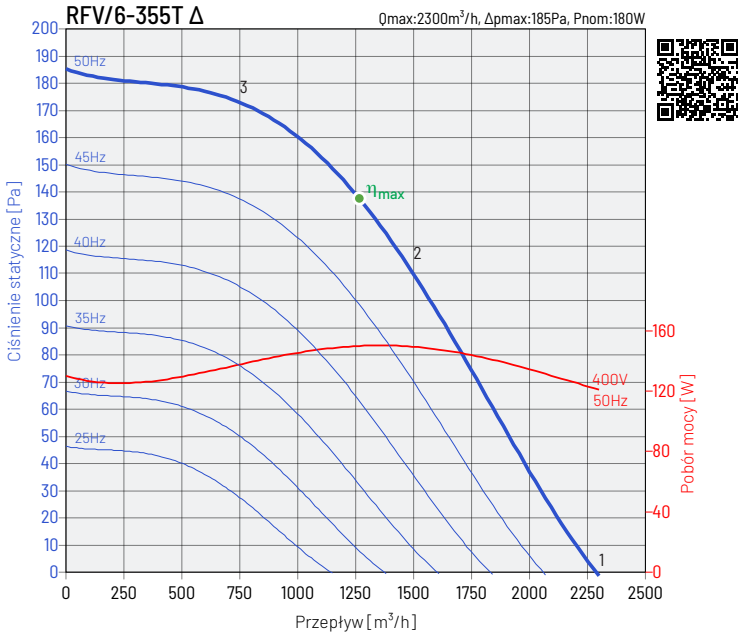

punkt pracy		63 Hz	125 Hz	250 Hz	500 Hz	1000 Hz	2000 Hz	4000 Hz	8000 Hz	L_{WA}
1	wlot	44	63	67	72	69	67	78	71	80
	wylot	54	63	67	70	69	67	68	52	76
2	wlot	45	60	64	69	66	64	74	66	77
	wylot	55	60	65	68	67	64	61	49	73
3	wlot	42	55	60	63	62	62	68	63	72
	wylot	53	59	62	65	65	63	60	47	71

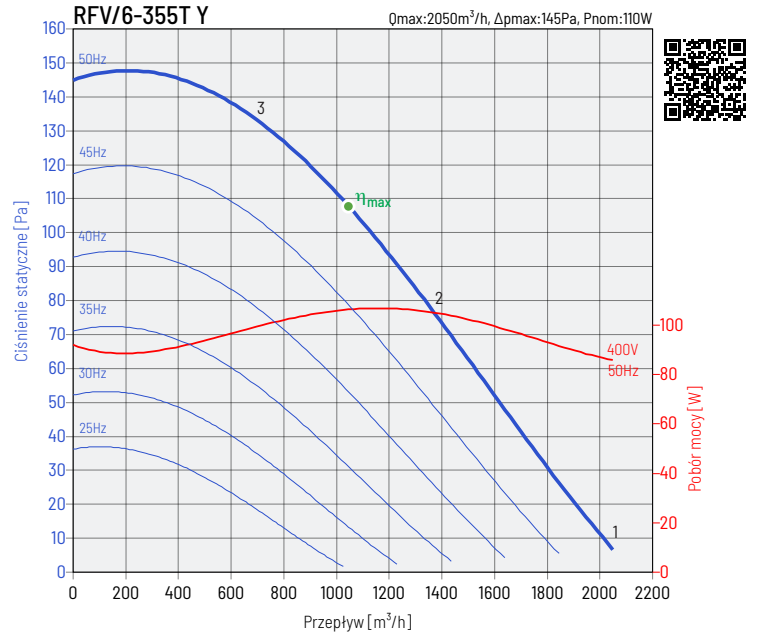

punkt pracy		63 Hz	125 Hz	250 Hz	500 Hz	1000 Hz	2000 Hz	4000 Hz	8000 Hz	L_{WA}
1	wlot	35	54	58	63	60	58	69	62	71
	wylot	53	56	58	60	60	61	59	40	67
2	wlot	37	52	56	61	58	56	66	58	69
	wylot	48	50	56	57	57	55	53	38	63
3	wlot	34	47	52	55	54	54	60	55	64
	wylot	43	45	48	53	50	48	45	34	57

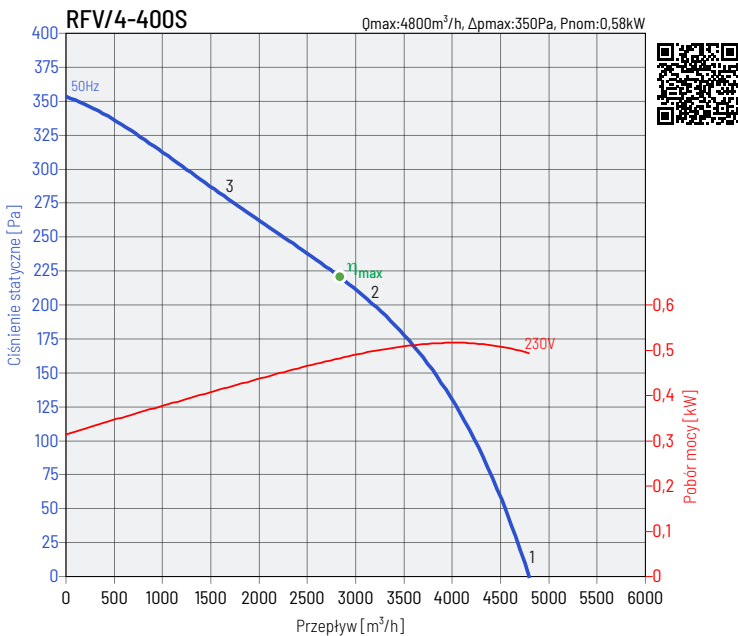

punkt pracy		63 Hz	125 Hz	250 Hz	500 Hz	1000 Hz	2000 Hz	4000 Hz	8000 Hz	L_{WA}
1	wlot	46	62	68	73	71	75	89	67	89
	wylot	60	68	75	77	79	75	74	61	84
2	wlot	47	62	67	70	66	68	69	53	75
	wylot	57	65	71	72	73	70	69	58	78
3	wlot	49	60	64	68	65	66	60	54	73
	wylot	53	62	66	67	70	66	61	49	74

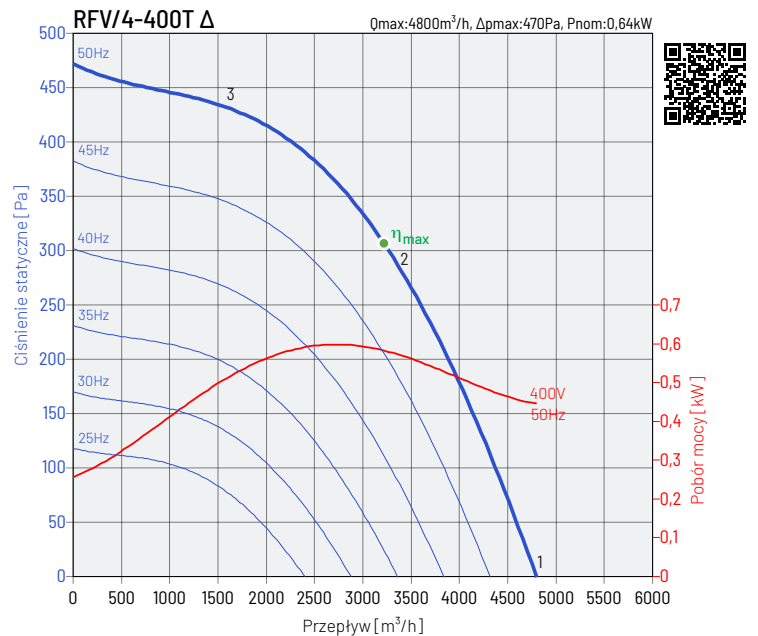

punkt pracy		63 Hz	125 Hz	250 Hz	500 Hz	1000 Hz	2000 Hz	4000 Hz	8000 Hz	L_{WA}
1	wlot	46	62	68	73	71	75	89	67	89
	wylot	60	68	76	78	80	76	75	61	85
2	wlot	47	62	67	70	66	68	69	53	75
	wylot	57	65	72	73	74	71	69	58	79
3	wlot	49	60	64	68	65	66	60	54	73
	wylot	54	62	66	68	71	68	62	50	75



CHARAKTERYSTYKI PRACY WENTYLATORÓW

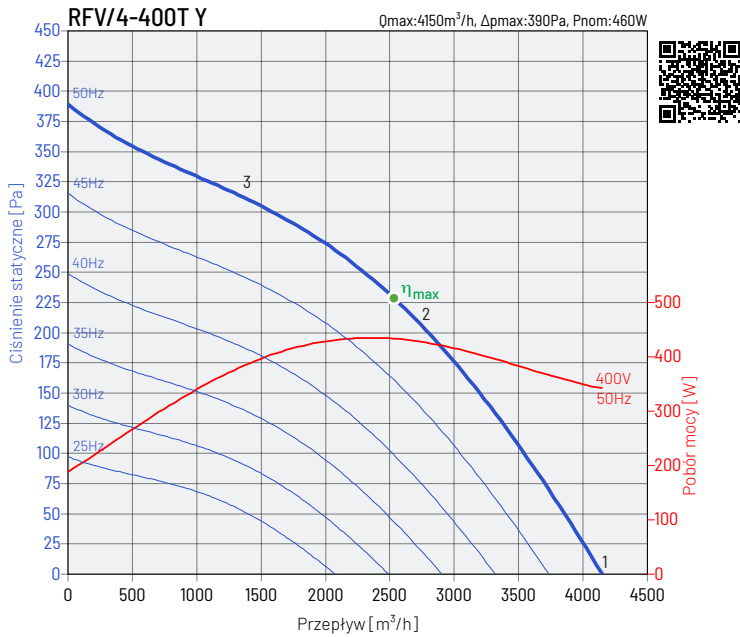

punkt pracy	63 Hz	125 Hz	250 Hz	500 Hz	1000 Hz	2000 Hz	4000 Hz	8000 Hz	L_{wa}
1	wlot								
	wylot								
2	wlot								
	wylot								
3	wlot								
	wylot								

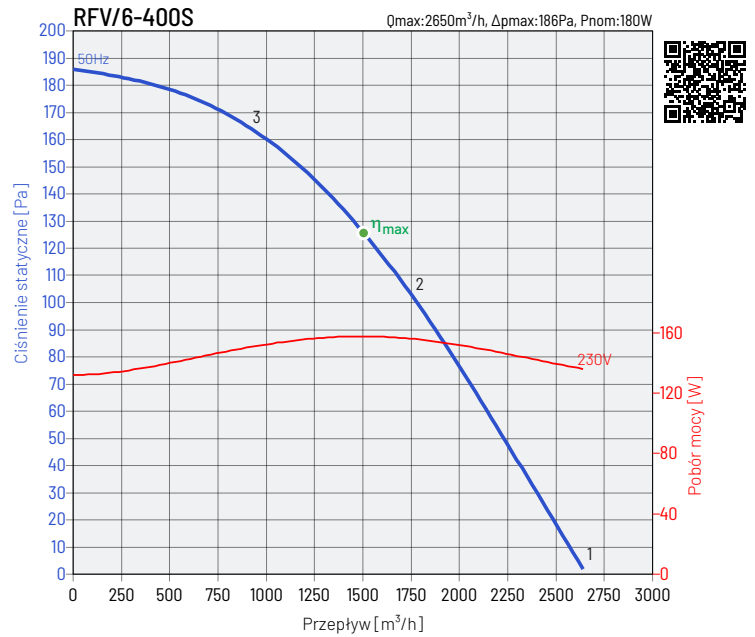

punkt pracy	63 Hz	125 Hz	250 Hz	500 Hz	1000 Hz	2000 Hz	4000 Hz	8000 Hz	L_{wa}
1	wlot	32	51	58	62	59	65	61	47
	wylot	50	61	65	64	68	66	65	51
2	wlot	27	45	51	56	53	55	52	42
	wylot	49	59	62	62	64	61	59	45
3	wlot	24	44	45	50	50	51	47	41
	wylot	47	55	58	60	60	56	51	39

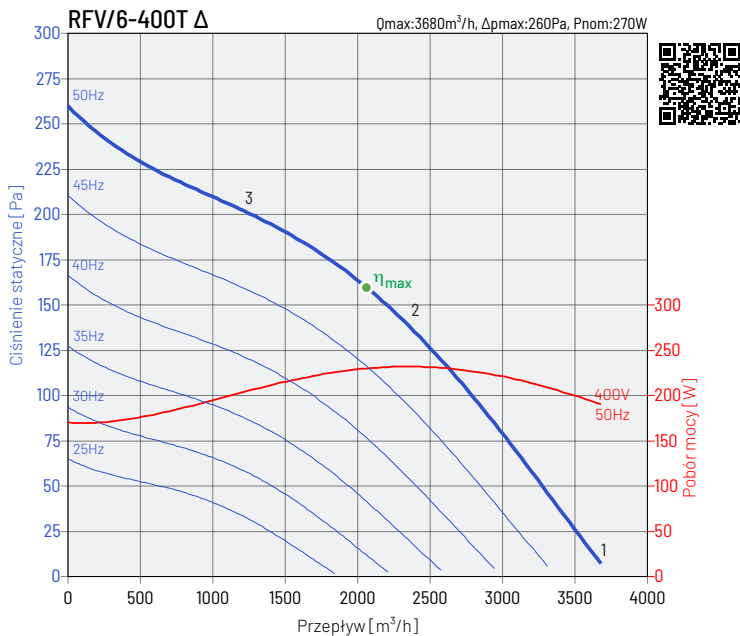

punkt pracy	63 Hz	125 Hz	250 Hz	500 Hz	1000 Hz	2000 Hz	4000 Hz	8000 Hz	L_{wa}
1	wlot	40	55	63	66	65	75	65	50
	wylot	60	59	64	67	69	66	59	42
2	wlot	37	49	55	58	56	62	51	40
	wylot	54	57	62	65	65	64	56	40
3	wlot	46	52	57	59	56	53	46	40
	wylot	50	54	57	62	64	59	51	38

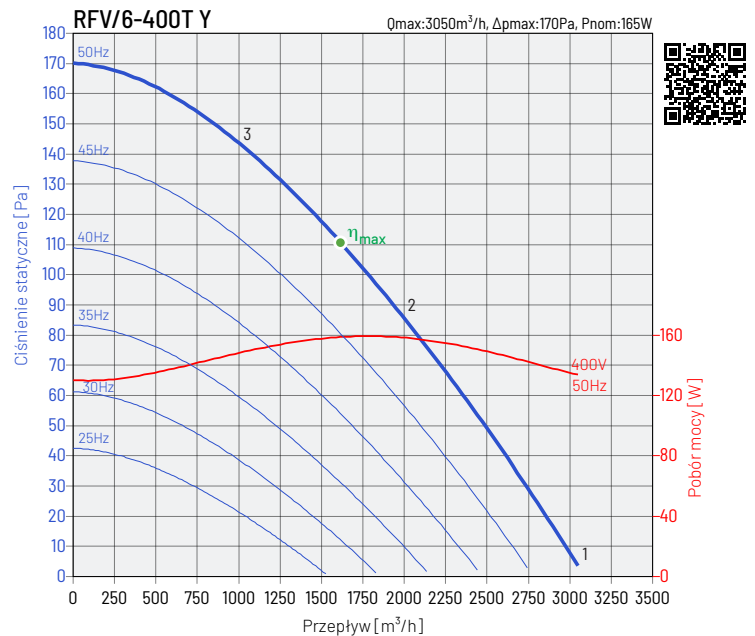

punkt pracy	63 Hz	125 Hz	250 Hz	500 Hz	1000 Hz	2000 Hz	4000 Hz	8000 Hz	L_{wa}
1	wlot								
	wylot								
2	wlot								
	wylot								
3	wlot								
	wylot								



CHARAKTERYSTYKI PRACY WENTYLATORÓW

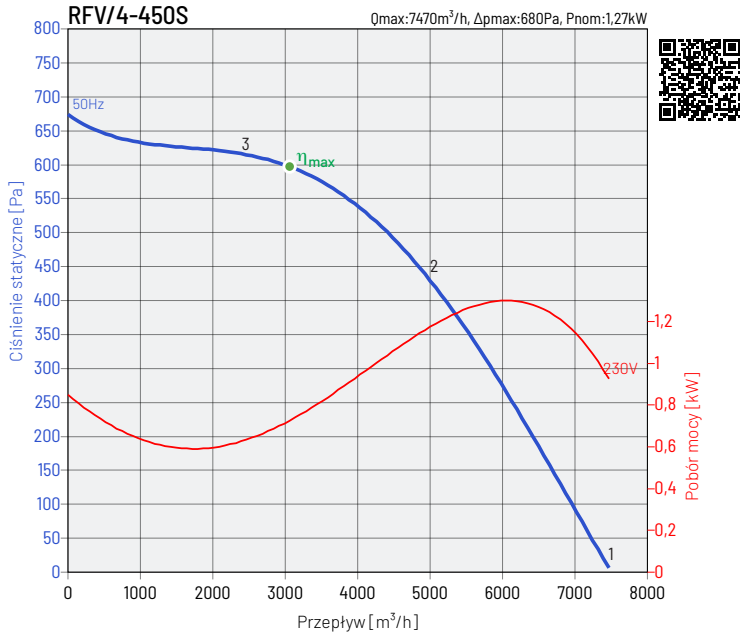

punkt pracy	63 Hz	125 Hz	250 Hz	500 Hz	1000 Hz	2000 Hz	4000 Hz	8000 Hz	L_{WA}	
1	wlot	53	72	78	81	80	77	73	63	86
	wylot	60	69	77	81	83	78	79	66	87
2	wlot	52	68	74	77	75	72	64	58	81
	wylot	56	66	74	77	78	76	74	62	83
3	wlot	49	62	69	70	69	68	60	56	75
	wylot	53	63	69	72	75	72	71	59	79

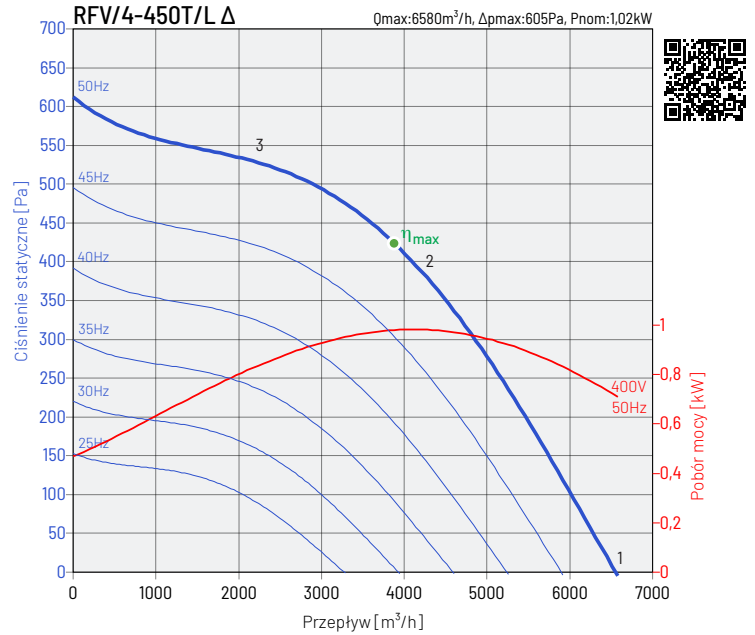

punkt pracy	63 Hz	125 Hz	250 Hz	500 Hz	1000 Hz	2000 Hz	4000 Hz	8000 Hz	L_{WA}	
1	wlot	47	66	72	74	72	76	68	60	80
	wylot	58	65	75	79	81	78	74	64	85
2	wlot	41	60	62	64	65	69	62	53	73
	wylot	54	61	71	78	77	75	71	62	82
3	wlot	54	67	68	68	67	66	59	52	74
	wylot	50	58	66	72	74	70	69	59	78

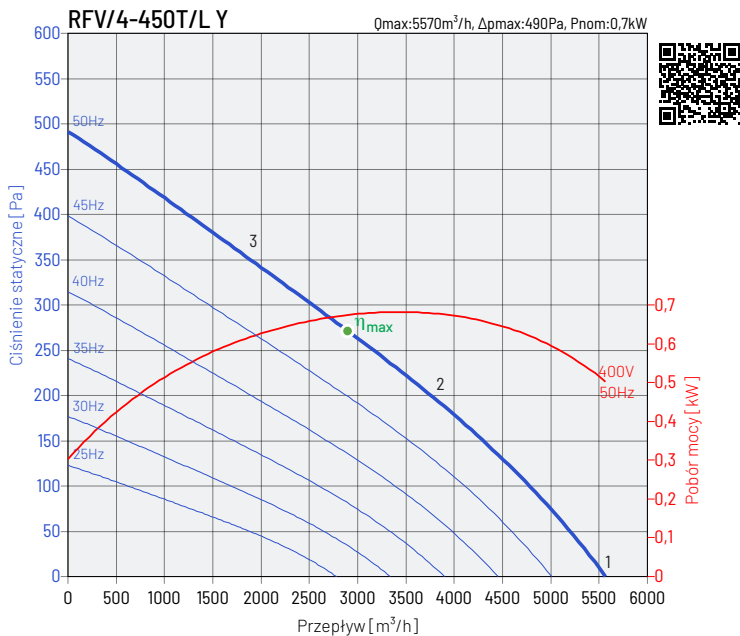

punkt pracy	63 Hz	125 Hz	250 Hz	500 Hz	1000 Hz	2000 Hz	4000 Hz	8000 Hz	L_{WA}	
1	wlot	47	66	74	72	76	68	60	80	
	wylot	58	65	75	79	81	78	74	64	85
2	wlot	41	60	62	64	65	69	62	53	73
	wylot	54	61	71	78	77	75	71	62	82
3	wlot	54	67	68	68	67	66	59	52	74
	wylot	50	58	66	72	74	70	69	59	78

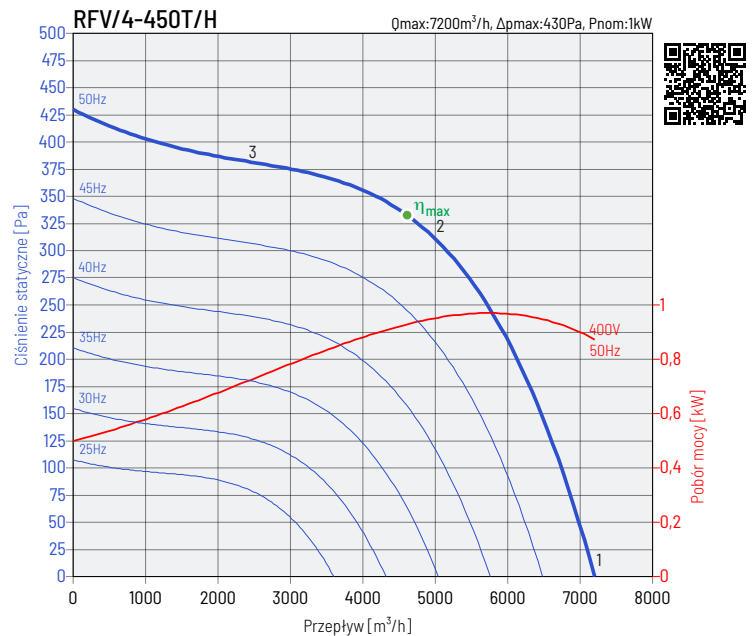

punkt pracy	63 Hz	125 Hz	250 Hz	500 Hz	1000 Hz	2000 Hz	4000 Hz	8000 Hz	L_{WA}	
1	wlot	43	60	64	67	68	70	70	63	76
	wylot	60	67	77	81	84	80	75	65	88
2	wlot	37	58	62	65	67	68	68	61	74
	wylot	57	64	73	79	80	77	71	62	84
3	wlot	34	56	60	63	65	66	63	56	71
	wylot	55	61	67	76	77	72	69	60	81



CHARAKTERYSTYKI PRACY WENTYLATORÓW

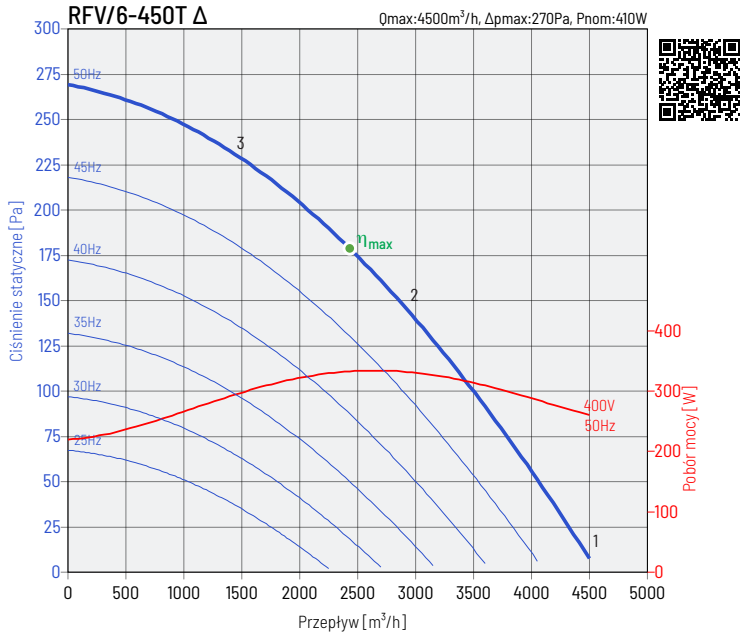

punkt pracy	63 Hz	125 Hz	250 Hz	500 Hz	1000 Hz	2000 Hz	4000 Hz	8000 Hz	L_{WA}	
1	wlot	44	63	69	72	71	68	64	54	77
	wylot	62	68	71	73	73	71	74	55	80
2	wlot	43	59	65	68	66	63	55	49	72
	wylot	59	65	69	71	70	69	66	51	77
3	wlot	39	52	59	60	59	58	50	46	65
	wylot	53	61	62	65	68	65	61	49	72

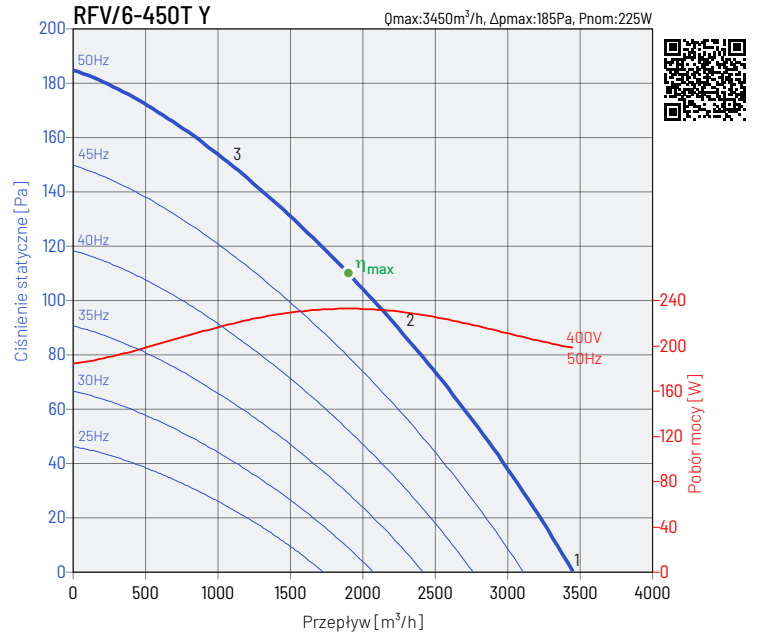

punkt pracy	63 Hz	125 Hz	250 Hz	500 Hz	1000 Hz	2000 Hz	4000 Hz	8000 Hz	L_{WA}	
1	wlot	44	63	69	72	71	68	64	54	77
	wylot	62	68	71	73	73	71	74	55	80
2	wlot	43	59	65	68	66	63	55	49	72
	wylot	59	65	69	71	70	69	66	51	77
3	wlot	39	52	59	60	59	58	50	46	65
	wylot	53	61	62	65	68	65	61	49	72

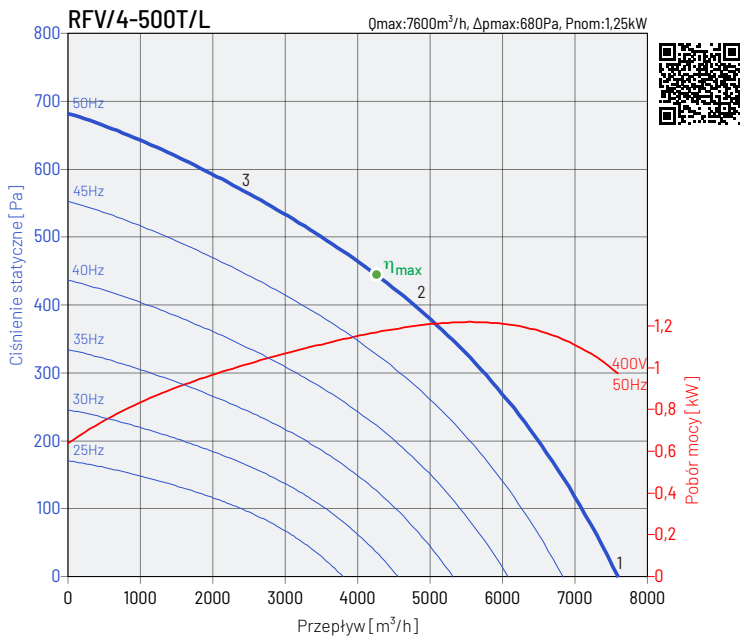

punkt pracy	63 Hz	125 Hz	250 Hz	500 Hz	1000 Hz	2000 Hz	4000 Hz	8000 Hz	L_{WA}	
1	wlot	49	68	70	71	70	70	65	78	
	wylot	65	74	79	81	85	80	79	65	89
2	wlot	46	65	67	68	67	65	66	62	75
	wylot	59	70	73	77	80	76	76	60	84
3	wlot	44	62	62	66	64	60	59	58	71
	wylot	56	66	67	72	76	74	73	56	80

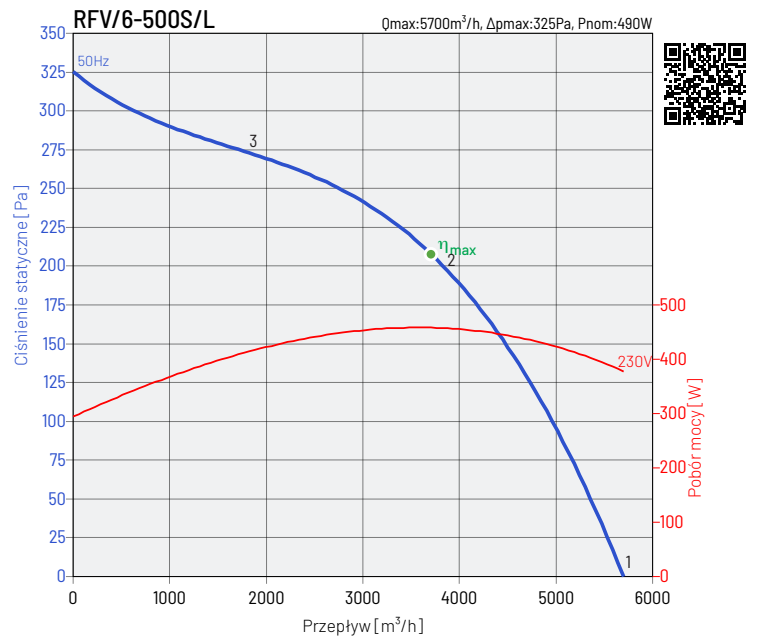

punkt pracy	63 Hz	125 Hz	250 Hz	500 Hz	1000 Hz	2000 Hz	4000 Hz	8000 Hz	L_{WA}	
1	wlot	43	60	67	70	69	73	72	70	78
	wylot	63	71	73	74	80	78	76	64	84
2	wlot	39	55	62	65	64	65	65	57	72
	wylot	59	69	74	72	78	75	73	61	82
3	wlot	34	54	57	59	62	64	61	54	69
	wylot	56	65	66	66	69	67	66	55	75



CHARAKTERYSTYKI PRACY WENTYLATORÓW

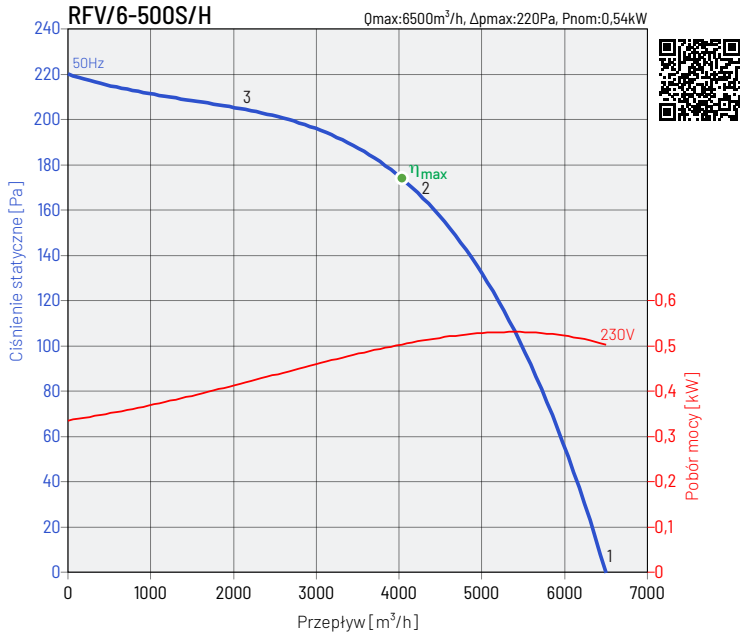

punkt pracy	63 Hz	125 Hz	250 Hz	500 Hz	1000 Hz	2000 Hz	4000 Hz	8000 Hz	L_{WA}	
1	wlot	43	58	66	63	65	66	64	58	72
	wylot	59	67	69	70	74	73	72	60	79
2	wlot	32	55	65	61	63	63	61	54	70
	wylot	57	65	66	66	71	68	69	58	76
3	wlot	32	55	65	59	61	62	57	48	69
	wylot	55	63	63	64	68	66	67	55	74

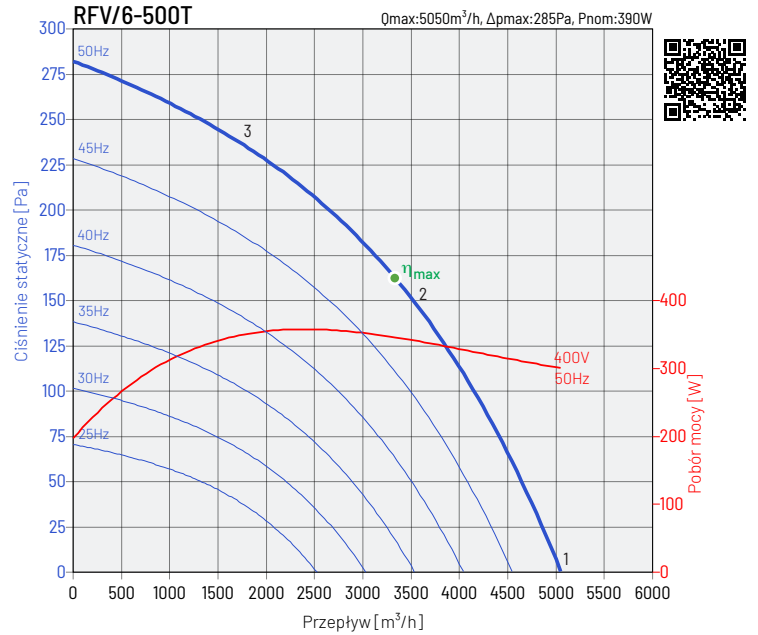

punkt pracy	63 Hz	125 Hz	250 Hz	500 Hz	1000 Hz	2000 Hz	4000 Hz	8000 Hz	L_{WA}	
1	wlot	47	55	60	63	64	61	56	68	71
	wylot	59	68	73	75	77	74	74	59	82
2	wlot	43	53	57	62	63	57	51	63	68
	wylot	56	63	68	69	70	66	68	53	76
3	wlot	41	49	55	60	60	55	50	55	65
	wylot	54	60	64	66	67	65	67	50	73

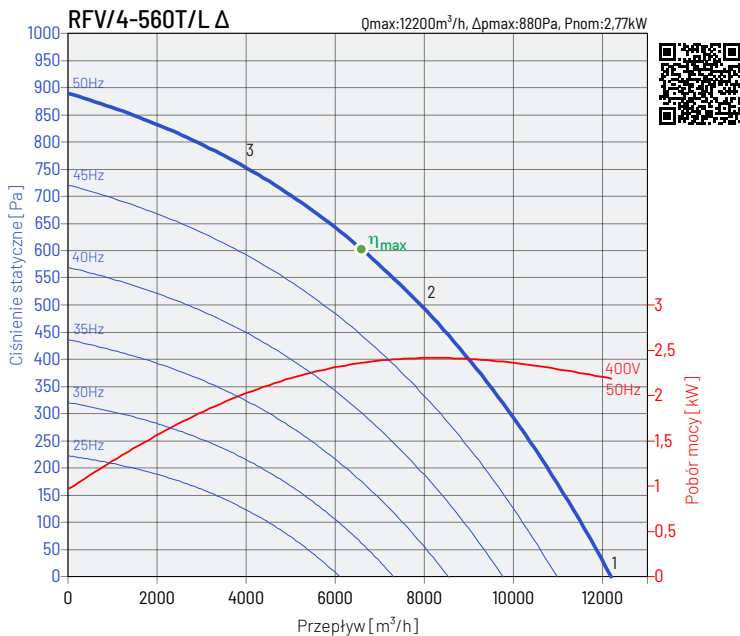

punkt pracy	63 Hz	125 Hz	250 Hz	500 Hz	1000 Hz	2000 Hz	4000 Hz	8000 Hz	L_{WA}
1	wlot								
	wylot								
2	wlot								
	wylot								
3	wlot								
	wylot								

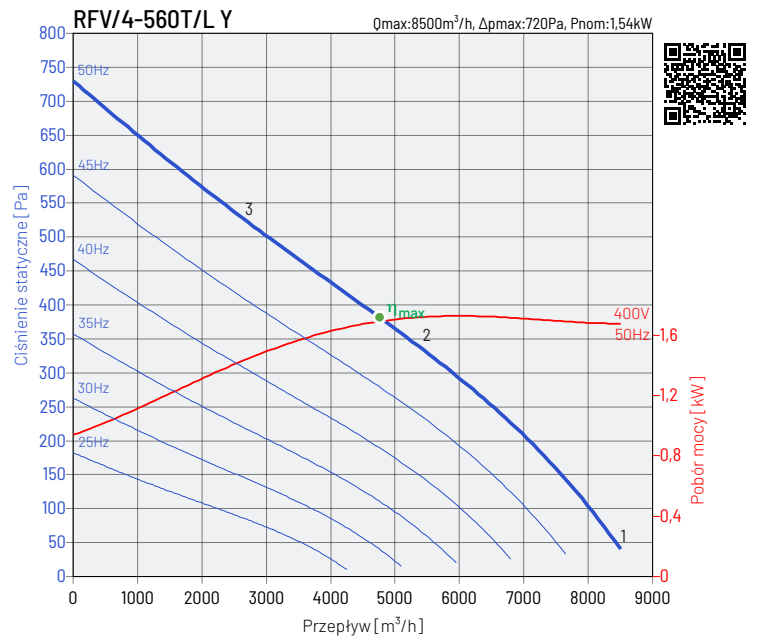

punkt pracy	63 Hz	125 Hz	250 Hz	500 Hz	1000 Hz	2000 Hz	4000 Hz	8000 Hz	L_{WA}	
1	wlot	50	67	69	72	73	73	73	69	80
	wylot	61	73	78	81	83	80	77	62	87
2	wlot	43	60	67	69	71	71	70	66	77
	wylot	59	70	76	77	80	78	75	56	85
3	wlot	43	60	64	68	69	69	67	61	75
	wylot	56	68	71	74	78	77	74	53	83



CHARAKTERYSTYKI PRACY WENTYLATORÓW

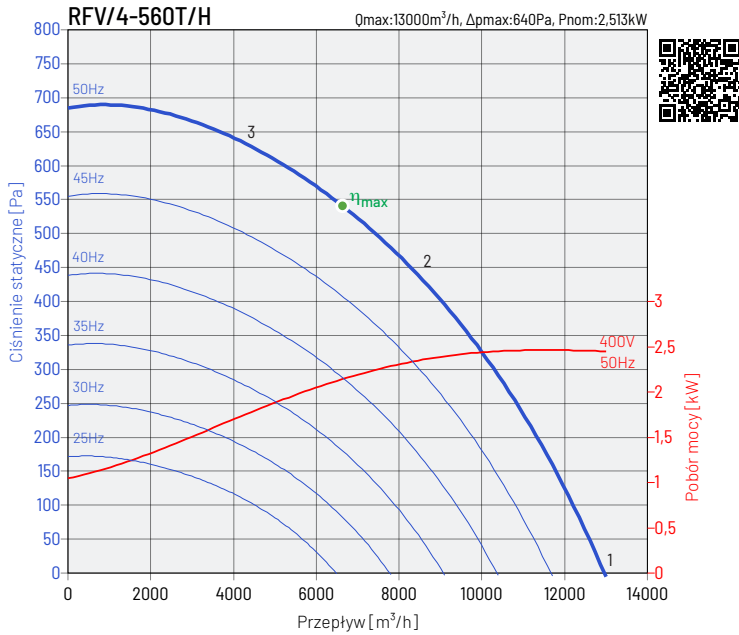

punkt pracy	63 Hz	125 Hz	250 Hz	500 Hz	1000 Hz	2000 Hz	4000 Hz	8000 Hz	L_{wa}
1	wlot	50	67	73	74	74	74	70	81
	wylot	62	73	79	81	83	82	79	88
2	wlot	43	61	68	70	72	71	70	78
	wylot	59	71	76	77	81	78	75	85
3	wlot	43	60	64	68	70	70	67	76
	wylot	56	68	72	74	78	77	74	83

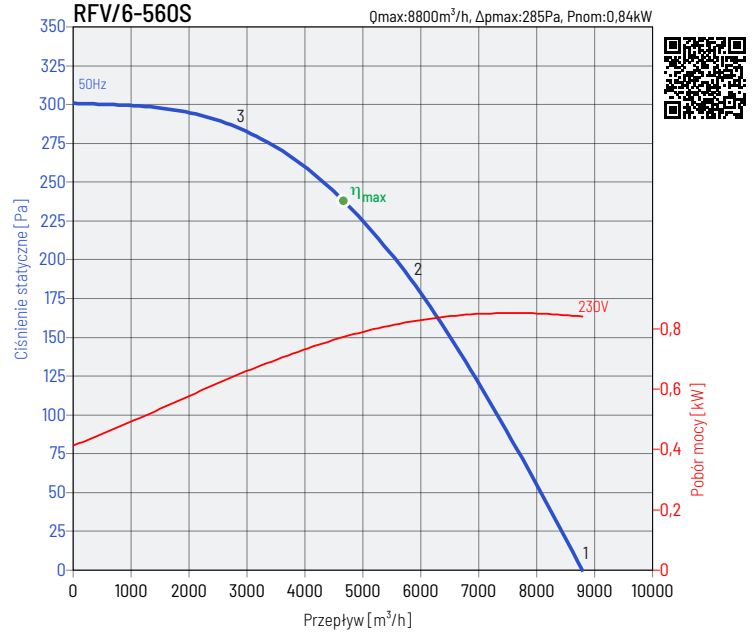

punkt pracy	63 Hz	125 Hz	250 Hz	500 Hz	1000 Hz	2000 Hz	4000 Hz	8000 Hz	L_{wa}
1	wlot	47	62	64	66	67	67	65	74
	wylot	57	66	72	70	72	71	71	79
2	wlot	38	58	61	63	64	63	60	70
	wylot	54	63	69	67	69	67	68	75
3	wlot	42	57	60	62	63	62	58	69
	wylot	52	62	66	65	66	66	68	74

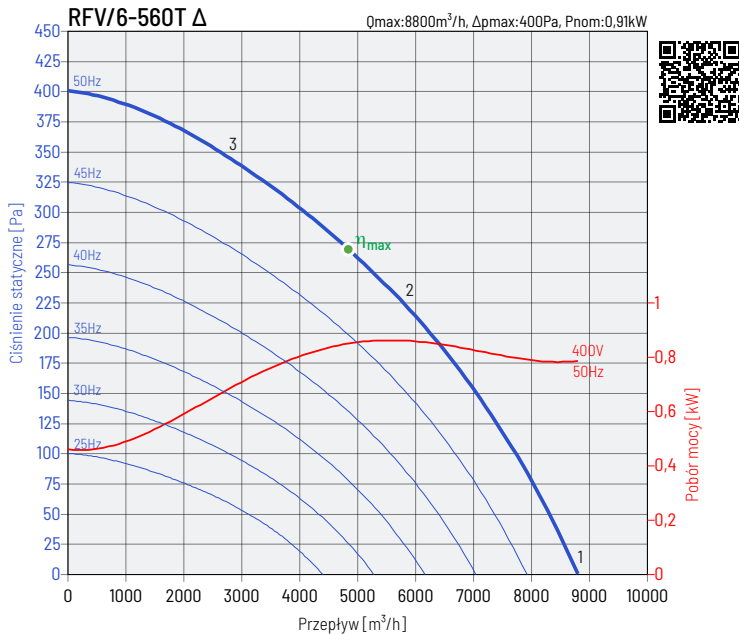

punkt pracy	63 Hz	125 Hz	250 Hz	500 Hz	1000 Hz	2000 Hz	4000 Hz	8000 Hz	L_{wa}
1	wlot	45	64	70	71	77	85	66	86
	wylot	59	68	73	72	76	75	71	81
2	wlot	40	61	64	64	65	72	62	82
	wylot	56	66	70	69	73	71	68	78
3	wlot	37	54	57	58	64	61	54	67
	wylot	53	62	65	67	71	67	63	75

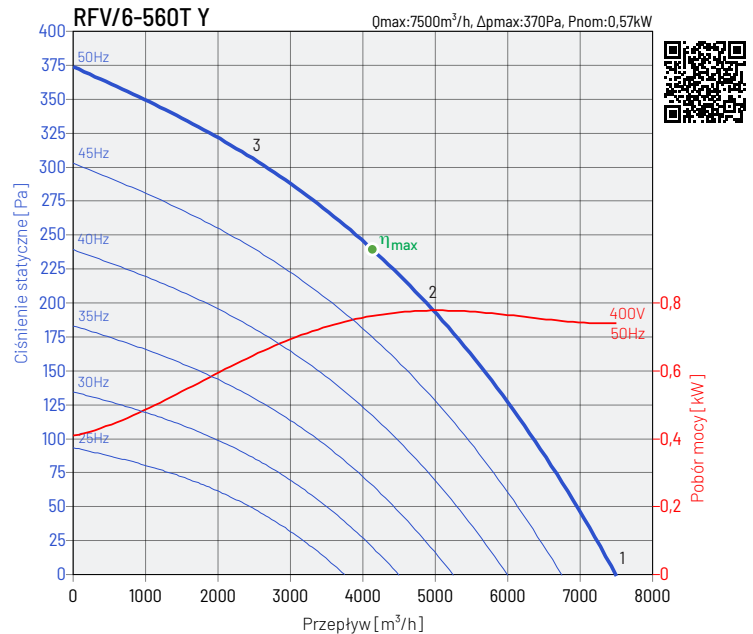

punkt pracy	63 Hz	125 Hz	250 Hz	500 Hz	1000 Hz	2000 Hz	4000 Hz	8000 Hz	L_{wa}
1	wlot	45	64	70	70	71	77	85	86
	wylot	59	68	73	72	76	75	71	81
2	wlot	40	61	64	64	65	72	62	82
	wylot	56	66	70	69	73	71	68	78
3	wlot	37	54	57	58	64	61	54	67
	wylot	53	62	65	67	71	67	63	75



CHARAKTERYSTYKI PRACY WENTYLATORÓW

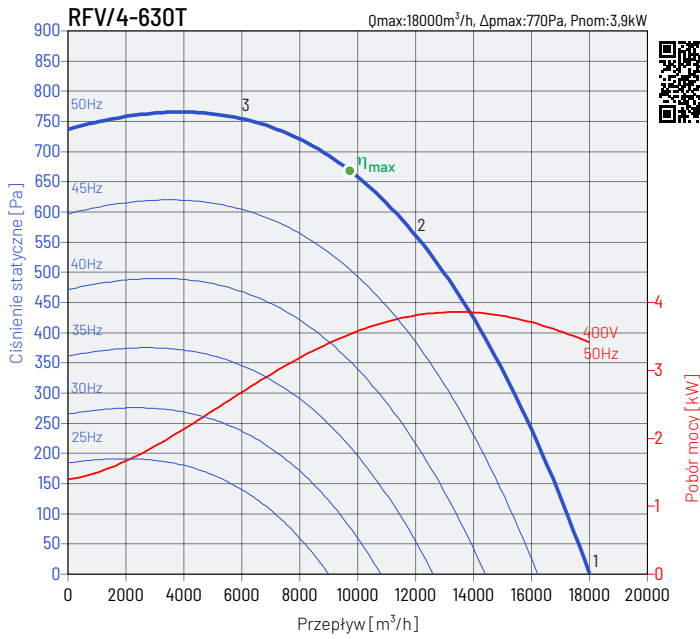

punkt pracy	63 Hz	125 Hz	250 Hz	500 Hz	1000 Hz	2000 Hz	4000 Hz	8000 Hz	L _{wa}
1									
wlot	61	72	77	76	80	77	67	62	84
wylot	62	74	77	80	82	78	68	63	86
2									
wlot	57	66	72	72	75	71	57	57	79
wylot	59	69	74	75	78	73	66	59	82
3									
wlot	59	68	74	75	78	73	67	60	82
wylot	61	70	76	77	80	75	69	62	84



ECO PROJECT

Nazwa produktu	RFV/4-125	RFV/4-160
a Nazwa dostawcy	VENTURE INDUSTRIES	VENTURE INDUSTRIES
b Numer artykułu	43522213	43522233
c JZE klimat umiarkowany [kWh/m²rok]	-17,14	-17,15
c JZE klimat chłodny [kWh/m²rok]	-33,54	-33,55
c JZE klimat ciepły [kWh/m²rok]	-7,75	-7,75
c JZE (SEC) klasa	E	E
d Kategoria urządzenia	SWM	SWM
d Typ urządzenia	JSW Jednokierunkowy	JSW Jednokierunkowy
e Napęd	Układ bezstopniowej regulacji prędkości obrotowej	Układ bezstopniowej regulacji prędkości obrotowej
f Typ odzysku ciepła	nie dotyczy	nie dotyczy
g Sprawność temperaturowa [%]	nie dotyczy	nie dotyczy
h Maksymalny przepływ powietrza [m³/h]	150	435
i Maksymalny pobór mocy [W]	41	70
j Moc akustyczna L _{wa} [dB(A)]	55	62
k Wartość odniesienia natężenia przepływu [m³/s]	0,03	0,09
l Wartość odniesienia różnicy ciśnienia [Pa]	50	50
m JPM [kW/(m³/h)]	0	0
n CRS	1	1
o Stopień zewnętrznych przecieków powietrza [%]	0	0
p Stopień mieszania	nie dotyczy	nie dotyczy
q Ostrzeżenia o konieczności wymiany filtra	nie dotyczy	nie dotyczy
r Instrukcja instalowania kratki wentylacyjnych	nie dotyczy	nie dotyczy
s Strona internetowa	www.venture.pl	www.venture.pl
t Podatność przepływu na zmiany ciśnienia	nie dotyczy	nie dotyczy
u Szczelność	nie dotyczy	nie dotyczy
v (RZE) klimat chłodny [kWh/m²rok]	342,4	201,58
v (RZE) klimat umiarkowany [kWh/m²rok]	342,4	201,58
v (RZE) klimat ciepły [kWh/m²rok]	342,4	201,58
w ROO klimat chłodny	3355,29	3355,29
w ROO klimat umiarkowany	1715,15	1715,15
w ROO klimat ciepły	775,57	775,57
MISC	1,1	1,1
CRS	1	1
x-wykładnik	1	1

Nazwa produktu	RFV/2-125S	RFV/2-160S/L	RFV/2-160S/H	RFV/2-200S	RFV/4-200S
a Nazwa dostawcy	VENTURE INDUSTRIES	VENTURE INDUSTRIES	VENTURE INDUSTRIES	VENTURE INDUSTRIES	VENTURE INDUSTRIES
b Numer artykułu	43528210	43528230	43528232	43528245	43528250
c Kategoria urządzenia	SWNM	SWNM	SWNM	SWNM	SWNM
c Typ urządzenia	JSW Jednokierunkowy	JSW Jednokierunkowy	JSW Jednokierunkowy	JSW Jednokierunkowy	JSW Jednokierunkowy
d Napęd	Układ bezstopniowej regulacji prędkości obrotowej	Układ bezstopniowej regulacji prędkości obrotowej	Układ bezstopniowej regulacji prędkości obrotowej	Układ bezstopniowej regulacji prędkości obrotowej	Układ bezstopniowej regulacji prędkości obrotowej
e Typ odzysku ciepła	nie dotyczy	nie dotyczy	nie dotyczy	nie dotyczy	nie dotyczy
f Sprawność temperaturowa [%]	nie dotyczy	nie dotyczy	nie dotyczy	nie dotyczy	nie dotyczy
g Znamionowe natężenie przepływu w SWNM [m³/s]	0,07	0,11	0,14	0,21	0,17
h Efektywny pobór mocy [kW]	0,06	0,10	0,14	0,26	0,09
i JMWint [W/(m³/s)]	798	902	951	1268	498
j Prędkość czołowa [m/s]	0,46	0,63	0,83	1,04	0,87
k Δps, ext [Pa]	239	252	298	445	133
l Δps, int [Pa]	nie dotyczy	nie dotyczy	nie dotyczy	nie dotyczy	nie dotyczy
m Δps, add [Pa]	nie dotyczy	nie dotyczy	nie dotyczy	nie dotyczy	nie dotyczy
n Sprawność statyczna wentylatora [%]	29,9	27,9	31,4	35,1	26,8
o Stopień zewnętrznych przecieków powietrza [%]	0	0	0	0	0
p Efektywność energetyczna filtra	nie dotyczy	nie dotyczy	nie dotyczy	nie dotyczy	nie dotyczy
q Ostrzeżenia o konieczności wymiany filtra	nie dotyczy	nie dotyczy	nie dotyczy	nie dotyczy	nie dotyczy
r L _{wa} [dB(A)]	60	64	66	70	56
s Strona internetowa	www.venture.pl	www.venture.pl	www.venture.pl	www.venture.pl	www.venture.pl



ECO PROJECT

Nazwa produktu	RFV/4-250S	RFV/4-250T	RFV/6-250S	RFV/4-315S	RFV/4-315T
a Nazwa dostawcy	VENTURE INDUSTRIES	VENTURE INDUSTRIES	VENTURE INDUSTRIES	VENTURE INDUSTRIES	VENTURE INDUSTRIES
b Numer artykułu	43528260	43528280	43528265	43528270	43528290
c Kategoria urządzenia	SWNM	SWNM	SWNM	SWNM	SWNM
d Typ urządzenia	JSW Jednokierunkowy	JSW Jednokierunkowy	JSW Jednokierunkowy	JSW Jednokierunkowy	JSW Jednokierunkowy
e Napęd	Układ bezstopniowej regulacji prędkości obrotowej	Układ bezstopniowej regulacji prędkości obrotowej	Układ bezstopniowej regulacji prędkości obrotowej	Układ bezstopniowej regulacji prędkości obrotowej	Układ bezstopniowej regulacji prędkości obrotowej
f Typ odzysku ciepła	nie dotyczy	nie dotyczy	nie dotyczy	nie dotyczy	nie dotyczy
g Sprawność temperaturowa [%]	nie dotyczy	nie dotyczy	nie dotyczy	nie dotyczy	nie dotyczy
h Znamionowe natężenie przepływu w SWNM [m ³ /s]	0,23	0,21	0,13	0,32	0,36
i Efektywny pobór mocy [kW]	0,11	0,12	0,05	0,16	0,23
j JMWint [W/(m ³ /s)]	449	573	338	508	640
k Prędkość czołowa [m/s]	1,06	0,83	0,54	1,16	1,28
l Δps, ext [Pa]	131	228	85	179	232
m Δps, int [Pa]	nie dotyczy	nie dotyczy	nie dotyczy	nie dotyczy	nie dotyczy
n Δps, add [Pa]	nie dotyczy	nie dotyczy	nie dotyczy	nie dotyczy	nie dotyczy
o Sprawność statyczna wentylatora [%]	29,2	39,8	25,1	35,3	36,2
p Stopień zewnętrznych przecieków powietrza [%]	0	0	0	0	0
q Efektywność energetyczna filtra	nie dotyczy	nie dotyczy	nie dotyczy	nie dotyczy	nie dotyczy
r Ostrzeżenia o konieczności wymiany filtra	nie dotyczy	nie dotyczy	nie dotyczy	nie dotyczy	nie dotyczy
s L _{WA} [dB(A)]	58	61	53	60	61
t Strona internetowa	www.venture.pl	www.venture.pl	www.venture.pl	www.venture.pl	www.venture.pl

Nazwa produktu	RFV/6-315S	RFV/4-355S	RFV/4-355T	RFV/6-355T	RFV/4-400S
a Nazwa dostawcy	VENTURE INDUSTRIES	VENTURE INDUSTRIES	VENTURE INDUSTRIES	VENTURE INDUSTRIES	VENTURE INDUSTRIES
b Numer artykułu	43528275	43528300	43528305	43528315	43528320
c Kategoria urządzenia	SWNM	SWNM	SWNM	SWNM	SWNM
d Typ urządzenia	JSW Jednokierunkowy	JSW Jednokierunkowy	JSW Jednokierunkowy	JSW Jednokierunkowy	JSW jednokierunkowy
e Napęd	Układ bezstopniowej regulacji prędkości obrotowej	Układ bezstopniowej regulacji prędkości obrotowej	Układ bezstopniowej regulacji prędkości obrotowej	Układ bezstopniowej regulacji prędkości obrotowej	Układ bezstopniowej regulacji prędkości obrotowej
f Typ odzysku ciepła	nie dotyczy	nie dotyczy	nie dotyczy	nie dotyczy	nie dotyczy
g Sprawność temperaturowa [%]	nie dotyczy	nie dotyczy	nie dotyczy	nie dotyczy	nie dotyczy
h Znamionowe natężenie przepływu w SWM [m ³ /s]	0,21	0,50	0,50	0,31	0,79
i Efektywny pobór mocy [kW]	0,08	0,44	0,42	0,15	0,48
j JMWint [W/(m ³ /s)]	388	884	844	473	610
k Prędkość czołowa [m/s]	0,75	1,59	1,58	0,98	2,24
l Δps, ext [Pa]	105	333	335	153	229
m Δps, int [Pa]	nie dotyczy	nie dotyczy	nie dotyczy	nie dotyczy	nie dotyczy
n Δps, add [Pa]	nie dotyczy	nie dotyczy	nie dotyczy	nie dotyczy	nie dotyczy
o Sprawność statyczna wentylatora [%]	27,1	37,7	39,7	32,4	37,6
p Stopień zewnętrznych przecieków powietrza [%]	0	0	0	0	0
q Efektywność energetyczna filtra	nie dotyczy	nie dotyczy	nie dotyczy	nie dotyczy	nie dotyczy
r Ostrzeżenia o konieczności wymiany filtra	nie dotyczy	nie dotyczy	nie dotyczy	nie dotyczy	nie dotyczy
s L _{WA} [dB(A)]	54	68	67	60	72
t Strona internetowa	www.venture.pl	www.venture.pl	www.venture.pl	www.venture.pl	www.venture.pl

Nazwa produktu	RFV/4-400T	RFV/6-400S	RFV/6-400T	RFV/4-450S	RFV/4-450T/L
a Nazwa dostawcy	VENTURE INDUSTRIES	VENTURE INDUSTRIES	VENTURE INDUSTRIES	VENTURE INDUSTRIES	VENTURE INDUSTRIES
b Numer artykułu	43528325	43528330	43528335	43528340	43528345
c Kategoria urządzenia	SWNM	SWNM	SWNM	SWNM	SWNM
d Typ urządzenia	JSW Jednokierunkowy	JSW jednokierunkowy	JSW jednokierunkowy	JSW Jednokierunkowy	JSW Jednokierunkowy
e Napęd	Układ bezstopniowej regulacji prędkości obrotowej	Układ bezstopniowej regulacji prędkości obrotowej	Układ bezstopniowej regulacji prędkości obrotowej	Układ bezstopniowej regulacji prędkości obrotowej	Układ bezstopniowej regulacji prędkości obrotowej
f Typ odzysku ciepła	nie dotyczy	nie dotyczy	nie dotyczy	nie dotyczy	nie dotyczy
g Sprawność temperaturowa [%]	nie dotyczy	nie dotyczy	nie dotyczy	nie dotyczy	nie dotyczy
h Znamionowe natężenie przepływu w SWM [m ³ /s]	0,80	0,37	0,64	1,08	1,20
i Efektywny pobór mocy [kW]	0,61	0,16	0,23	1,24	1,00
j JMWint [W/(m ³ /s)]	763	424	367	1148	833
k Prędkość czołowa [m/s]	2,25	1,05	1,80	2,75	3,06
l Δps, ext [Pa]	353	142	144	553	388
m Δps, int [Pa]	nie dotyczy	nie dotyczy	nie dotyczy	nie dotyczy	nie dotyczy
n Δps, add [Pa]	nie dotyczy	nie dotyczy	nie dotyczy	nie dotyczy	nie dotyczy
o Sprawność statyczna wentylatora [%]	46,2	33,5	39,2	48,2	46,6
p Stopień zewnętrznych przecieków powietrza [%]	0	0	0	0	0
q Efektywność energetyczna filtra	nie dotyczy	nie dotyczy	nie dotyczy	nie dotyczy	nie dotyczy
r Ostrzeżenia o konieczności wymiany filtra	nie dotyczy	nie dotyczy	nie dotyczy	nie dotyczy	nie dotyczy
s L _{WA} [dB(A)]	71	62	61	72	75
t Strona internetowa	www.venture.pl	www.venture.pl	www.venture.pl	www.venture.pl	www.venture.pl



ECO PROJECT

Nazwa produktu	RFV/6-500T	RFV/4-560T/L	RFV/4-560T/H	RFV/6-560S	RFV/6-560T	RFV/4-630T
a Nazwa dostawcy	VENTURE INDUSTRIES	VENTURE INDUSTRIES	VENTURE INDUSTRIES	VENTURE INDUSTRIES	VENTURE INDUSTRIES	VENTURE INDUSTRIES
b Numer artykułu	43528375	43528380	43528381	43528382	43528385	43528390
c Kategoria urządzenia	SWNM	SWNM	SWNM	SWNM	SWNM	SWNM
d Typ urządzenia	JSW Jednokierunkowy	JSW Jednokierunkowy	JSW Jednokierunkowy	JSW Jednokierunkowy	JSW Jednokierunkowy	JSW Jednokierunkowy
e Napęd	Układ bezstopniowej regulacji prędkości obrotowej	Układ bezstopniowej regulacji prędkości obrotowej	Układ bezstopniowej regulacji prędkości obrotowej	Układ bezstopniowej regulacji prędkości obrotowej	Układ bezstopniowej regulacji prędkości obrotowej	Układ bezstopniowej regulacji prędkości obrotowej
f Typ odzysku ciepła	nie dotyczy	nie dotyczy	nie dotyczy	nie dotyczy	nie dotyczy	nie dotyczy
g Sprawność temperaturowa [%]	nie dotyczy	nie dotyczy	nie dotyczy	nie dotyczy	nie dotyczy	nie dotyczy
h Znamionowe natężenie przepływu w SWM [m ³ /s]	1,08	1,82	1,80	1,45	1,42	2,76
i Efektywny pobór mocy [kW]	0,33	2,32	2,12	0,80	0,85	3,51
j JMWint [W/(m ³ /s)]	306	1276	1178	552	595	1268
k Prędkość czołowa [m/s]	2,45	3,67	3,64	2,92	2,88	4,96
l Δps, ext [Pa]	125	613	554	227	256	668
m Δps, int [Pa]	nie dotyczy	nie dotyczy	nie dotyczy	nie dotyczy	nie dotyczy	nie dotyczy
n Δps, add [Pa]	nie dotyczy	nie dotyczy	nie dotyczy	nie dotyczy	nie dotyczy	nie dotyczy
o Sprawność statyczna wentylatora [%]	40,8	48,0	47,0	41,2	43,0	52,6
p Stopień zewnętrznych przecieków powietrza [%]	0	0	0	0	0	0
q Efektywność energetyczna filtra	nie dotyczy	nie dotyczy	nie dotyczy	nie dotyczy	nie dotyczy	nie dotyczy
r Ostrzeżenia o konieczności wymiany filtra	nie dotyczy	nie dotyczy	nie dotyczy	nie dotyczy	nie dotyczy	nie dotyczy
s L _{WA} [dB(A)]	64	74	74	66	68	74
t Strona internetowa	www.venture.pl	www.venture.pl	www.venture.pl	www.venture.pl	www.venture.pl	www.venture.pl

Nazwa produktu	RFV/4-450T/H	RFV/6-450T	RFV/4-500T/L	RFV/6-500S/L	RFV/6-500S/H
a Nazwa dostawcy	VENTURE INDUSTRIES	VENTURE INDUSTRIES	VENTURE INDUSTRIES	VENTURE INDUSTRIES	VENTURE INDUSTRIES
b Numer artykułu	43528350	43528355	43528370	43528372	43528373
c Kategoria urządzenia	SWNM	SWNM	SWNM	SWNM	SWNM
d Typ urządzenia	JSW Jednokierunkowy	JSW Jednokierunkowy	JSW Jednokierunkowy	JSW Jednokierunkowy	JSW Jednokierunkowy
e Napęd	Układ bezstopniowej regulacji prędkości obrotowej	Układ bezstopniowej regulacji prędkości obrotowej	Układ bezstopniowej regulacji prędkości obrotowej	Układ bezstopniowej regulacji prędkości obrotowej	Układ bezstopniowej regulacji prędkości obrotowej
f Typ odzysku ciepła	nie dotyczy	nie dotyczy	nie dotyczy	nie dotyczy	nie dotyczy
g Sprawność temperaturowa [%]	nie dotyczy	nie dotyczy	nie dotyczy	nie dotyczy	nie dotyczy
h Znamionowe natężenie przepływu w SWM [m ³ /s]	1,35	0,6	1,09	1,21	1,08
i Efektywny pobór mocy [kW]	0,94	0,33	1,16	0,45	0,51
j JMWint [W/(m ³ /s)]	698	548	1070	368	427
k Prędkość czołowa [m/s]	3,43	1,52	2,47	2,76	2,45
l Δps, ext [Pa]	323	197	467	162	180
m Δps, int [Pa]	nie dotyczy	nie dotyczy	nie dotyczy	nie dotyczy	nie dotyczy
n Δps, add [Pa]	nie dotyczy	nie dotyczy	nie dotyczy	nie dotyczy	nie dotyczy
o Sprawność statyczna wentylatora [%]	46,3	36,0	43,7	43,5	38,1
p Stopień zewnętrznych przecieków powietrza [%]	0	0	0	0	0
q Efektywność energetyczna filtra	nie dotyczy	nie dotyczy	nie dotyczy	nie dotyczy	nie dotyczy
r Ostrzeżenia o konieczności wymiany filtra	nie dotyczy	nie dotyczy	nie dotyczy	nie dotyczy	nie dotyczy
s L _{WA} [dB(A)]	75	63	73	67	65
t Strona internetowa	www.venture.pl	www.venture.pl	www.venture.pl	www.venture.pl	www.venture.pl

WYMIARY

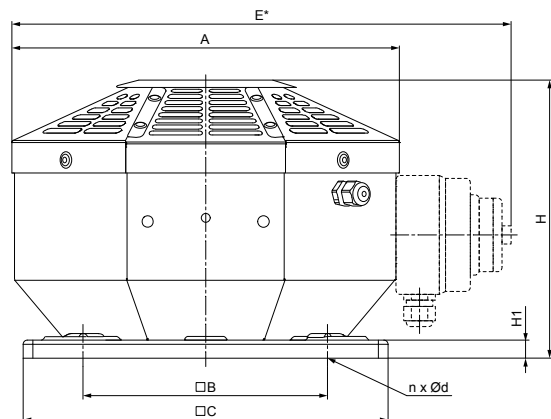

model wentylatora	A mm	B mm	C mm	H mm	H1 mm	n	Ød mm	E* mm
RFV-125S	320	245	300	229	15	4	10	418
RFV-160S	320	245	300	229	15	4	10	418
RFV-200S	425	330	435	230	15	4	12	511
RFV-250x	480	330	435	301	15	4	12	578
RFV-315x	550	330	435	308	15	4	12	648
RFV-355x	680	450	560	390	15	4	12	709
RFV-400x	685	450	560	390	15	4	12	706
RFV-450x	750	535	630	421	15	4	12	767
RFV-500x	845	590	710	461	17	4	12	861
RFV-560x	956	750	900	552	43	4	14	956
RFV-630x	1121	750	900	630	43	4	14	1121

* dotyczy wersji z wyłącznikiem serwisowym.



AKCESORIA MONTAŻOWE - Montaż typu A

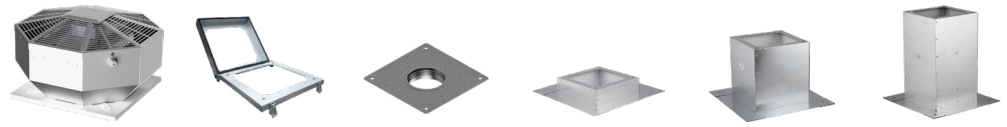
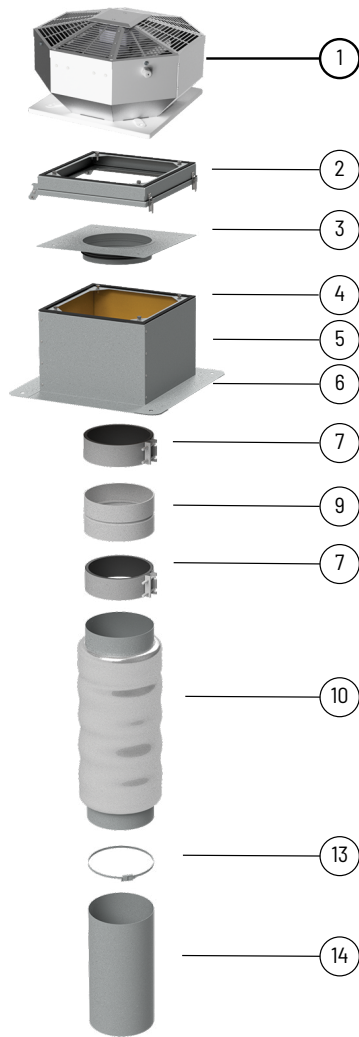

	1	2	3	4	5	6
wentylator	moduł uchylny U	płyta z króćcem PZK	podstawa dachowa RSS	podstawa dachowa RS	podstawa dachowa RSA	
RFV-125	U 300	PZK-125	RSS 300	RS 300	RSA 300	
RFV-160	U 300	PZK-160	RSS 300	RS 300	RSA 300	
RFV-200	U 435	PZK-200	RSS 435	RS 435	RSA 435	
RFV-250	U 435	PZK-250	RSS 435	RS 435	RSA 435	
RFV-315	U 435	PZK-315	RSS 435	RS 435	RSA 435	
RFV-355	U 560	-	RSS 560	RS 560	RSA 560	
RFV-400	U 560	-	RSS 560	RS 560	RSA 560	
RFV-450	U 630	-	RSS 630	RS 630	RSA 630	
RFV-500	U 710	-	RSS 710	RS 710	RSA 710	
RFV-560	U 905	-	RSS 905	RS 905	RSA 905	
RFV-630	U 905	-	RSS 905	RS 905	RSA 905	



	7	9	10	13	14
wentylator	opaska przeciwdrg. ACOP PL	kłapa zwrotna CAR-PL	tłumik AKU-COMP	opaska zaciskowa SBF	przewód wentylacyjny VENTAL
RFV-125	ACOP PL 125	CAR-PL 125	AKU-COMP 125	SBF 60-135	VENTAL 127
RFV-160	ACOP PL 160	CAR-PL 160	AKU-COMP 160	SBF 60-165	VENTAL 165
RFV-200	ACOP PL 200	CAR-PL 200	AKU-COMP 200	SBF 60-215	VENTAL 203
RFV-250	ACOP PL 250	CAR-PL 250	AKU-COMP 250	SBF 60-325	VENTAL 254
RFV-315	ACOP PL 315	CAR-PL 315	AKU-COMP 315	SBF 60-325	VENTAL 315
RFV-355	-	-	-	-	-
RFV-400	-	-	-	-	-
RFV-450	-	-	-	-	-
RFV-500	-	-	-	-	-
RFV-560	-	-	-	-	-
RFV-630	-	-	-	-	-



AKCESORIA MONTAŻOWE - Montaż typu B

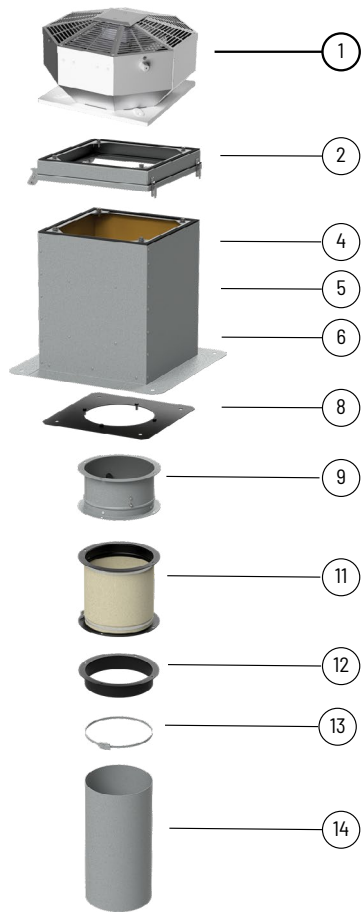

1 wentylator	2 moduł uchylny U	4 podstawa dachowa RSS	5 podstawa dachowa RS	6 podstawa dachowa RSA	8 płyta montażowa P
RFV-125	U 300	RSS 300	RS 300	RSA 300	P 300
RFV-160	U 300	RSS 300	RS 300	RSA 300	P 300
RFV-200	U 435	RSS 435	RS 435	RSA 435	P 435
RFV-250	U 435	RSS 435	RS 435	RSA 435	P 435
RFV-315	U 435	RSS 435	RS 435	RSA 435	P 435
RFV-355	U 560	RSS 560	RS 560	RSA 560	P 560
RFV-400	U 560	RSS 560	RS 560	RSA 560	P 560
RFV-450	U 630	RSS 630	RS 630	RSA 630	P 630
RFV-500	U 710	RSS 710	RS 710	RSA 710	P 710
RFV-560	U 905	RSS 905	RS 905	RSA 905	P 905
RFV-630	U 905	RSS 905	RS 905	RSA 905	P 905



1 wentylator	9 klapa zwrotna KZD	11 złącze przeciwdrg. ZDPO	12 króciec montażowy K	13 opaska zaciskowa SBF	14 przewód wentylacyjny VENTAL
RFV-125	KZD 300	ZDPO 300	K 300	SBF 60-135	VENTAL 165
RFV-160	KZD 300	ZDPO 300	K 300	SBF 60-165	VENTAL 165
RFV-200	KZD 435	ZDPO 435	K 435	SBF 60-215	VENTAL 254
RFV-250	KZD 435	ZDPO 435	K 435	SBF 60-325	VENTAL 254
RFV-315	KZD 435	ZDPO 435	K 435	SBF 60-325	VENTAL 254
RFV-355	KZD 560-N	ZDPO 560	K 560	-	-
RFV-400	KZD 560-N	ZDPO 560	K 560	-	-
RFV-450	KZD 630-N	ZDPO 630	K 630	-	-
RFV-500	KZD 710-N	ZDPO 710	K 710	-	-
RFV-560	KZD 905-N	ZDPO 905	K 905	-	-
RFV-630	KZD 905-N	ZDPO 905	K 905	-	-



AKCESORIA MONTAŻOWE - Montaż typu C

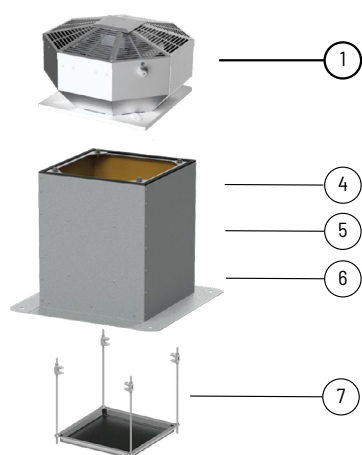

1	4	5	6	7
wentylator	podstawa dachowa RSS	podstawa dachowa RS	podstawa dachowa RSA	taca ociekowa T
RFV-125	RSS 300	RS 300	RSA 300	T 300
RFV-160	RSS 300	RS 300	RSA 300	T 300
RFV-200	RSS 435	RS 435	RSA 435	T 435
RFV-250	RSS 435	RS 435	RSA 435	T 435
RFV-315	RSS 435	RS 435	RSA 435	T 435
RFV-355	RSS 560	RS 560	RSA 560	T 560
RFV-400	RSS 560	RS 560	RSA 560	T 560
RFV-450	RSS 630	RS 630	RSA 630	T 630
RFV-500	RSS 710	RS 710	RSA 710	T 710
RFV-560	RSS 905	RS 905	RSA 905	T 905
RFV-630	RSS 905	RS 905	RSA 905	T 905

Numery artykułów

43527200 U 300	43526510 RSS 300	40521815 ACOP PL 125	40521020-01 CAR-PL 125	40521520 AKU-COMP 125	18520165-01 SBF 60-165
43527210 U 435	43526520 RSS 435	40521820 ACOP PL 160	40521030-01 CAR-PL 160	40521530 AKU-COMP 160	18520215-01 SBF 60-215
43527220 U 560	43526530 RSS 560	40521825 ACOP PL 200	40521040-01 CAR-PL 200	40521540 AKU-COMP 200	18520325-01 SBF 60-325
43527230 U 630	43526540 RSS 630	40521830 ACOP PL 250	40521050-01 CAR-PL 250	40521550 AKU-COMP 250	11027127 VENTAL 127
43527240 U 710	43526550 RSS 710	40521835 ACOP PL 315	40521060-01 CAR-PL 315	40521560 AKU-COMP 315	11027165 VENTAL 165
43527250 U 905	43526560 RSS 905	43526300 P 300	43527300 KZD 300	43527400 ZDPO 300	11027203 VENTAL 203
43528610 PZK-125	43526010 RS 300	43526310 P 435	43527310 KZD 435	43527410 ZDPO 435	11027254 VENTAL 254
43528620 PZK-160	43526020 RS 435	43526320 P 560	43527320 KZD 560	43527420 ZDPO 560	11027315 VENTAL 315
43528630 PZK-200	43526030 RS 560	43526330 P 630	43527330 KZD 630	43527430 ZDPO 630	43527500 T 300
43528640 PZK-250	43526040 RS 630	43526340 P 710	43527340 KZD 710	43527440 ZDPO 710	43527510 T 435
43528650 PZK-315	43526050 RS 710	43526350 P 905	43527350 KZD 905	43527450 ZDPO 905	43527520 T 560
	43526060 RS 905			43526400 K 300	43527530 T 630
	43526110 RSA 300			43526410 K 435	43527540 T 710
	43526120 RSA 435			43526420 K 560	43527550 T 905
	43526130 RSA 560			43526430 K 630	
	43526140 RSA 630			43526440 K 710	
	43526150 RSA 710			43526450 K 905	
	43526160 RSA 905				



AKCESORIA ELEKTRYCZNE



wentylator	termostat ścienny	termostat kanałowy	czujnik zanieczyszc.	higrostat	regulator tyrystorowy	regulator tyrystorowy	regulator tyrystorowy	2-nastawowy 6-biegowy regulator tyrystorowy
	TS	TK-21	SQA	HIG-2	REB N	REB NE	VREB	RND-1
RFV/2-125S	TS	TK-21	SQA	HIG-2	REB-1N	REB-1NE	VREB 1.5H	RND-1
RFV/4-125S	TS	TK-21	SQA	HIG-2	REB-1N	REB-1NE	VREB 1.5H	RND-1
RFV/2-160S	TS	TK-21	SQA	HIG-2	REB-1N	REB-1NE	VREB 1.5H	RND-1
RFV/2-160S	TS	TK-21	SQA	HIG-2	REB-1N	REB-1NE	VREB 1.5H	RND-1
RFV/4-160S	TS	TK-21	SQA	HIG-2	REB-1N	REB-1NE	VREB 1.5H	RND-1
RFV/2-200S	TS	TK-21	SQA	HIG-2	REB-2,5N	REB-2,5NE	VREB 1.5H	RND-1
RFV/4-200S	TS	TK-21	SQA	HIG-2	REB-1N	REB-1NE	VREB 1.5H	RND-1
RFV/4-250S	TS	TK-21	SQA	HIG-2	REB-2,5N	REB-2,5NE	VREB 2.5H	RND-1
RFV/4-250T	TS + DILM7-10	TK-21 + DILM7-10	SQA + DILM7-10	HIG-2 + DILM7-10	-	-	-	-
RFV/6-250S	TS	TK-21	SQA	HIG-2	REB-1N	REB-1NE	VREB 1.5H	RND-1
RFV/4-315S	TS	TK-21	SQA	HIG-2	REB-2,5N	REB-2,5NE	VREB 2.5H	RND-1
RFV/4-315T	TS + DILM7-10	TK-21 + DILM7-10	SQA + DILM7-10	HIG-2 + DILM7-10	-	-	-	-
RFV/6-315S	TS	TK-21	SQA	HIG-2	REB-1N	REB-1NE	VREB 1.5H	RND-1
RFV/4-355S	TS	TK-21	SQA	HIG-2	REB-5	-	-	-
RFV/4-355T	TS + DILM7-10	TK-21 + DILM7-10	SQA + DILM7-10	HIG-2 + DILM7-10	-	-	-	-
RFV/6-355T	TS + DILM7-10	TK-21 + DILM7-10	SQA + DILM7-10	HIG-2 + DILM7-10	-	-	-	-
RFV/4-400S	TS	TK-21	SQA	HIG-2	REB-5	-	-	-
RFV/4-400T	TS + DILM7-10	TK-21 + DILM7-10	SQA + DILM7-10	HIG-2 + DILM7-10	-	-	-	-
RFV/6-400S	TS	TK-21	SQA	HIG-2	REB-2,5N	REB-2,5NE	VREB 2.5H	RND-1
RFV/6-400T	TS + DILM7-10	TK-21 + DILM7-10	SQA + DILM7-10	HIG-2 + DILM7-10	-	-	-	-
RFV/4-450S	TS	TK-21	SQA	HIG-2	REB-10	-	-	-
RFV/4-450T	TS + DILM7-10	TK-21 + DILM7-10	SQA + DILM7-10	HIG-2 + DILM7-10	-	-	-	-
RFV/4-450T	TS + DILM7-10	TK-21 + DILM7-10	SQA + DILM7-10	HIG-2 + DILM7-10	-	-	-	-
RFV/6-450T	TS + DILM7-10	TK-21 + DILM7-10	SQA + DILM7-10	HIG-2 + DILM7-10	-	-	-	-
RFV/4-500T	TS + DILM7-10	TK-21 + DILM7-10	SQA + DILM7-10	HIG-2 + DILM7-10	-	-	-	-
RFV/6-500S	TS	TK-21	SQA	HIG-2	REB-5	-	-	-
RFV/6-500S	TS	TK-21	SQA	HIG-2	REB-5	-	-	-
RFV/6-500T	TS + DILM7-10	TK-21 + DILM7-10	SQA + DILM7-10	HIG-2 + DILM7-10	-	-	-	-
RFV/4-560T	TS + DILM7-10	TK-21 + DILM7-10	SQA + DILM7-10	HIG-2 + DILM7-10	-	-	-	-
RFV/4-560T	TS + DILM7-10	TK-21 + DILM7-10	SQA + DILM7-10	HIG-2 + DILM7-10	-	-	-	-
RFV/6-560S	TS	TK-21	SQA	HIG-2	REB-5	-	-	-
RFV/6-560T	TS + DILM7-10	TK-21 + DILM7-10	SQA + DILM7-10	HIG-2 + DILM7-10	-	-	-	-
RFV/6-630T	TS + DILM7-10	TK-21 + DILM7-10	SQA + DILM7-10	HIG-2 + DILM7-10	-	-	-	-

Numery artykułów

91040997 DILM7-10

40025345 TS
40025320 TK-21
40025140 SQA
40025150 HIG-2

40025010 REB-1N
40025030 REB-2,5N
40025051 REB-5
40025055 REB-10
40025020 REB-1NE
40025040 REB-2,5NE

40025830 VREB 1.5H
40025840 VREB 2.5H

40025630 RND-1



AKCESORIA ELEKTRYCZNE



wentylator	regulator	regulator transformatorowy	regulator transformatorowy	regulator transformatorowy	regulator transformatorowy 2-nastawowy	falownik	wyłącznik serwisowy	wyłącznik serwisowy
	ERV	RMB	RVS	RMT	SC2A	L	R-S	RS
RFV/2-125S	ERV 3	RMB 1,5	RVS 1,5	-	SC2A1-15L25	-	R-S 1-F + SP, 10A	RS 1F-2B SP 16A
RFV/4-125S	ERV 3	RMB 1,5	RVS 1,5	-	SC2A1-15L25	-	R-S 1-F + SP, 10A	RS 1F-2B SP 16A
RFV/2-160S	ERV 3	RMB 1,5	RVS 1,5	-	SC2A1-15L25	-	R-S 1-F + SP, 10A	RS 1F-2B SP 16A
RFV/2-160S	ERV 3	RMB 1,5	RVS 1,5	-	SC2A1-15L25	-	R-S 1-F + SP, 10A	RS 1F-2B SP 16A
RFV/4-160S	ERV 3	RMB 1,5	RVS 1,5	-	SC2A1-15L25	-	R-S 1-F + SP, 10A	RS 1F-2B SP 16A
RFV/2-200S	ERV 3	RMB 1,5	RVS 1,5	-	SC2A1-25L25	-	R-S 1-F + SP, 10A	RS 1F-2B SP 16A
RFV/4-200S	ERV 3	RMB 1,5	RVS 1,5	-	SC2A1-15L25	-	R-S 1-F + SP, 10A	RS 1F-2B SP 16A
RFV/4-250S	ERV 3	RMB 1,5	RVS 1,5	-	SC2A1-15L25	-	R-S 1-F + SP, 10A	RS 1F-2B SP 16A
RFV/4-250T	-	-	-	RMT 1,5	SC2A4-15L55	L 0.4kW	-	RS 3F-3B SP 10A
RFV/6-250S	ERV 3	RMB 1,5	RVS 1,5	-	SC2A1-15L25	-	R-S 1-F + SP, 10A	RS 1F-2B SP 16A
RFV/4-315S	ERV 3	RMB 3,5	RVS 3	-	SC2A1-25L25	-	R-S 1-F + SP, 10A	RS 1F-2B SP 16A
RFV/4-315T	-	-	-	RMT 1,5	SC2A4-15L55	L 0.4kW	-	RS 3F-3B SP 10A
RFV/6-315S	ERV 3	RMB 1,5	RVS 1,5	-	SC2A1-15L25	-	R-S 1-F + SP, 10A	RS 1F-2B SP 16A
RFV/4-355S	ERV 3	RMB 3,5	RVS 3	-	SC2A1-25L25	-	R-S 1-F + SP, 10A	RS 1F-2B SP 16A
RFV/4-355T	-	-	-	RMT 1,5	SC2A4-15L55	L 0.4kW	-	RS 3F-3B SP 10A
RFV/6-355T	-	-	-	RMT 1,5	SC2A4-15L55	L 0.4kW	-	RS 3F-3B SP 10A
RFV/4-400S	ERV 3	RMB 3,5	RVS 3	-	SC2A1-35L25	-	R-S 1-F + SP, 10A	RS 1F-2B SP 16A
RFV/4-400T	-	-	-	RMT 1,5	SC2A4-15L55	L 0.75kW	-	RS 3F-3B SP 10A
RFV/6-400S	ERV 3	RMB 1,5	RVS 3	-	SC2A1-15L25	-	R-S 1-F + SP, 10A	RS 1F-2B SP 16A
RFV/6-400T	-	-	-	RMT 1,5	SC2A4-15L55	L 0.4kW	-	RS 3F-3B SP 10A
RFV/4-450S	ERV 10	RMB 8	RVS 7	-	SC2A1-75L25	-	R-S 1-F + SP, 10A	RS 1F-2B SP 16A
RFV/4-450T	-	-	-	RMT 2,5	SC2A4-25L55	L 0.75kW	-	RS 3F-3B SP 10A
RFV/4-450T	-	-	-	RMT 5	SC2A4-40L55	L 1,5kW	-	RS 3F-3B SP 10A
RFV/6-450T	-	-	-	RMT 1,5	SC2A4-15L55	L 0.4kW	-	RS 3F-3B SP 10A
RFV/4-500T	-	-	-	RMT 5	SC2A4-40L55	L 1,5kW	-	RS 3F-3B SP 10A
RFV/6-500S	ERV 3	RMB 3,5	RVS 3	-	SC2A1-35L25	-	R-S 1-F + SP, 10A	RS 1F-2B SP 16A
RFV/6-500S	ERV 3	RMB 3,5	RVS 3	-	SC2A1-35L25	-	R-S 1-F + SP, 10A	RS 1F-2B SP 16A
RFV/6-500T	-	-	-	RMT 1,5	SC2A4-15L55	L 0.4kW	-	RS 3F-3B SP 10A
RFV/4-560T	-	-	-	RMT 8	SC2A4-60L55	L 2,2kW	-	RS 3F-3B SP 10A
RFV/4-560T	-	-	-	RMT 8	SC2A4-60L55	L 2,2kW	-	RS 3F-3B SP 10A
RFV/6-560S	ERV5	RMB 8	RVS 7	-	SC2A1-50L25	-	R-S 1-F + SP, 10A	RS 1F-2B SP 16A
RFV/6-560T	-	-	-	RMT 2,5	SC2A4-25L55	L 0.75kW	-	RS 3F-3B SP 10A
RFV/6-630T	-	-	-	RMT 8	SC2A4-60L55	L 2,2kW	-	RS 3F-3B SP 10A

Numerы artykułów

40025046 ERV 3	40025060 RMB 1,5	40025251 SC2A1-15L25	40016302 L 0,4kW	91040907-01 R-S 1-F + SP, 10A	91040907-02 RS 1F-2B SP 16A
40025053 ERV 5	40025070 RMB 3,5	40025253 SC2A1-25L25	40016312 L 0,75kW		91040908-01 RS 3F-3B SP 10A
40025054 ERV 10	40025080 RMB 8	40025255 SC2A1-35L25	40016322 L 1,5kW		
	40025232 RVS 1,5	40025257 SC2A1-50L25	40016332 L 2,2kW		
	40025234 RVS 3	40025259 SC2A1-75L25			
	40025236 RVS 7	40025270 SC2A4-15L55			
	40025100 RMT 1,5	40025272 SC2A4-25L55			
	40025105 RMT 2,5	40025274 SC2A4-40L55			
	40025115 RMT 5	40025276 SC2A4-60L55			
	40025120 RMT 8				