



## ZASTOSOWANIE

Wentylator przeznaczony do wszelkiego rodzaju instalacji wentylacji ogólnej. Typowe zastosowania to:

- wentylacja mieszkań, biur,
- wentylacja bibliotek, sal konferencyjnych, sal szkolnych, studiów dźwiękowych,
- wentylacja budynków użyteczności publicznej, restauracji.

## KONSTRUKCJA

- obudowa z galwanizowanej blachy stalowej,
- ognioodporna warstwa izolacji akustycznej (włókno szklane M0) o grubości 50mm,
- wirnik z galwanizowanej blachy stalowej, z łopatkami pochylonymi do przodu,
- króćce przyłączeniowe o profilu okrągłym wyposażone w gumowe uszczelki,
- cztery wsporniki montażowe,
- możliwość montażu w dowolnej pozycji,
- otwierana obudowa umożliwiająca konserwację bez demontażu urządzenia z instalacji,
- wyłącznik zasilania ON-OFF na obudowie urządzenia.

## SILNIK ELEKTRYCZNY

- bezszczotkowe silniki EC, jednofazowe 230V, 50/60Hz,
- stopień ochrony IP44,
- do regulacji za pomocą potencjometru umieszczonego na pokrywie skrzynki zasilania,
- do regulacji za pomocą zewnętrznego potencjometru (zalecany REB ECOWATT),
- z możliwością sterowania sygnałem analogowym 0-10V,
- termiczne zabezpieczenie uzwojenia przed przeciążeniem.



WWW



DTR



CE



Wersja z silnikiem jednobiegowym - CAB

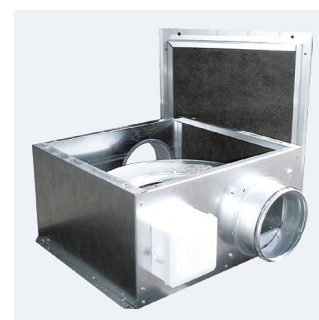

Wersja z silnikiem trzybiegowym - CAB PLUS



Wersja z wirniko-silnikiem - CAB B

## DANE TECHNICZNE

Typ	napięcie	prędkość obrotowa	pobór mocy max	natężenie	wydajność max	poziom ciśnienia akustycznego*			masa	ErP	nr artykułu
						wlot	emitowany	wylot			
	[V]	[obr/min]	[W]	[A]	[m³/h]	[dB(A)]			[kg]		
CAB-125 ECOWATT	10	3900	75	0,5	400	46	51	37	13	2018	41020460
	8	3550	57	0,4	355	44	49	35			
	6	2600	27	0,2	260	37	42	34			
	4	1800	12	0,1	185	28	33	25			
CAB-150 ECOWATT	10	3270	103	0,7	600	47	50	38	15	2018	41020461
	8	2980	78	0,6	540	45	47	36			
	6	2300	38	0,3	410	39	41	33			
	4	1610	16	0,1	280	30	33	26			
CAB-160 ECOWATT	10	3270	102	0,7	590	47	51	41	15	2018	41020462
	8	3020	81	0,5	530	45	49	40			
	6	2350	41	0,3	410	39	43	36			
	4	1620	18	0,1	280	30	34	27			
CAB-200 ECOWATT	10	2570	161	1,1	1090	48	53	39	23	2018	41020463
	8	2195	100	0,7	910	44	49	36			
	6	1715	50	0,4	710	37	43	31			
	4	1250	23	0,2	520	29	36	26			
CAB-250 ECOWATT	10	2650	219	1,4	1220	52	58	42	24	2018	41020464
	8	2390	162	1,1	1100	47	50	29			
	6	1905	85	0,6	880	42	45	27			
	4	1410	40	0,3	660	37	38	21			
CAB-315 ECOWATT	10	1990	238	1	1910	54	57	52	28	2018	41020465
	8	1670	143	0,6	1610	50	53	48			
	6	1390	88	0,4	1360	45	48	40			
	4	1060	46	0,2	1010	38	42	35			
CAB-355 ECOWATT	10	1940	335	1,4	2580	54	58	49	32	2018	41020466
	8	1685	224	1	2260	52	55	46			
	6	1380	130	0,6	1840	50	50	39			
	4	1070	69	0,3	1440	40	43	33			
CAB-400 ECOWATT	10	1940	335	1,4	2650	54	55	48	32	2018	41020467
	8	1695	229	1,1	2320	50	53	48			
	6	1380	131	0,6	1900	45	48	40			
	4	1070	68	0,3	1460	38	42	35			

\* pomiar z odległości 1,5 m od wentylatora

## CHARAKTERYSTYKI PRACY I CHARAKTERYSTYKI AKUSTYCZNE

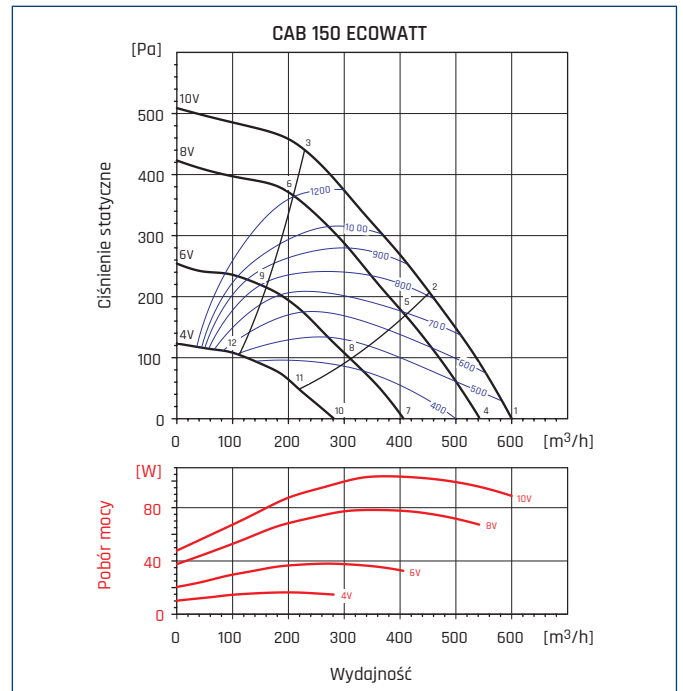
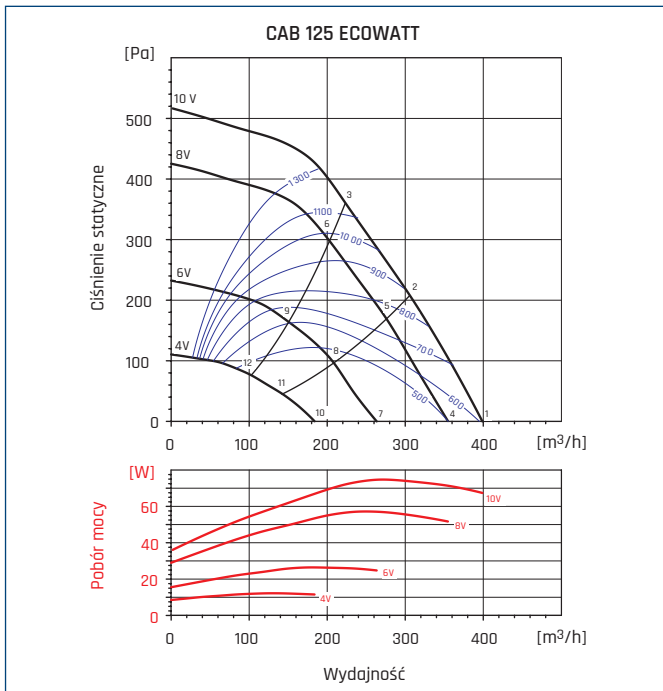

Częst. Hz/dB(A)	63	125	250	500	1000	2000	4000	8000	L <sub>WA</sub>	
1	Wlot	39	47	52	60	61	60	55	57	66
	Wylot	40	49	50	51	56	57	55	48	62
	Emitowany	40	47	46	43	41	44	42	40	53
2	Wlot	37	44	52	60	61	57	54	55	65
	Wylot	38	47	47	49	54	56	53	46	60
	Emitowany	37	44	46	43	40	42	41	38	51
3	Wlot	34	42	53	59	61	56	52	53	65
	Wylot	35	44	47	48	53	55	52	45	59
	Emitowany	35	42	47	42	41	41	40	36	51
4	Wlot	39	44	50	57	59	57	53	54	64
	Wylot	47	46	47	49	53	54	52	45	59
	Emitowany	37	44	45	41	38	42	40	38	50
5	Wlot	38	42	50	57	59	55	51	52	63
	Wylot	47	45	45	47	51	53	50	42	58
	Emitowany	35	42	45	42	38	39	38	35	49
6	Wlot	37	41	51	56	59	54	50	49	62
	Wylot	47	43	45	46	50	53	49	42	57
	Emitowany	34	40	46	40	38	38	37	33	49
7	Wlot	36	40	49	52	52	51	48	44	58
	Wylot	35	41	46	42	46	47	44	34	53
	Emitowany	38	39	45	37	37	39	36	32	48
8	Wlot	36	38	50	51	51	49	46	41	57
	Wylot	35	41	45	41	44	46	42	31	52
	Emitowany	38	37	46	37	35	37	34	29	48
9	Wlot	36	38	48	52	50	48	43	39	56
	Wylot	34	41	44	40	44	48	41	32	52
	Emitowany	38	37	44	38	35	36	32	27	47
10	Wlot	24	31	36	42	43	43	37	26	48
	Wylot	25	33	34	33	36	39	34	23	43
	Emitowany	23	32	33	30	30	32	33	25	40
11	Wlot	24	31	37	42	42	40	33	26	47
	Wylot	24	32	34	32	33	37	31	23	42
	Emitowany	23	32	33	30	28	29	29	25	39
12	Wlot	23	30	35	42	41	38	30	25	46
	Wylot	24	33	34	33	35	37	29	23	42
	Emitowany	22	32	32	30	28	27	25	24	38

Częst. Hz/dB(A)	63	125	250	500	1000	2000	4000	8000	L <sub>WA</sub>	
1	Wlot	43	49	53	59	61	59	58	51	66
	Wylot	44	52	52	53	57	57	54	44	62
	Emitowany	42	45	48	46	43	45	42	34	54
2	Wlot	40	49	52	58	58	56	55	49	64
	Wylot	39	51	50	50	55	56	52	43	61
	Emitowany	39	45	47	45	40	41	39	32	52
3	Wlot	38	47	56	59	59	55	54	49	64
	Wylot	38	49	53	50	55	58	53	45	62
	Emitowany	37	43	51	46	41	41	37	32	53
4	Wlot	41	47	52	57	59	57	56	48	64
	Wylot	41	50	50	50	54	55	52	41	60
	Emitowany	42	44	48	43	42	43	40	33	52
5	Wlot	39	47	51	55	56	53	53	46	61
	Wylot	36	50	49	48	53	54	50	40	59
	Emitowany	40	43	46	41	39	40	37	31	50
6	Wlot	36	45	54	56	56	53	51	46	62
	Wylot	34	48	52	47	54	55	50	43	60
	Emitowany	37	42	50	42	39	39	35	31	52
7	Wlot	35	42	47	51	53	52	48	38	58
	Wylot	33	44	45	43	47	48	45	31	54
	Emitowany	35	39	44	38	37	40	35	28	48
8	Wlot	32	41	47	49	50	48	44	36	55
	Wylot	32	44	45	43	46	48	43	31	53
	Emitowany	32	38	45	35	34	36	31	26	47
9	Wlot	30	42	47	49	49	47	43	37	55
	Wylot	31	46	47	42	49	49	42	33	55
	Emitowany	31	38	44	36	34	35	30	27	46
10	Wlot	27	35	40	43	45	43	34	26	50
	Wylot	29	37	37	34	38	39	31	23	45
	Emitowany	25	34	38	30	31	35	28	24	42
11	Wlot	26	34	39	41	42	40	32	26	47
	Wylot	29	35	36	33	37	39	29	23	44
	Emitowany	25	33	36	28	28	31	25	24	40
12	Wlot	26	39	39	41	42	37	31	25	47
	Wylot	28	40	35	40	41	39	30	23	46
	Emitowany	24	37	36	28	28	29	25	23	41

## CHARAKTERYSTYKI PRACY I CHARAKTERYSTYKI AKUSTYCZNE

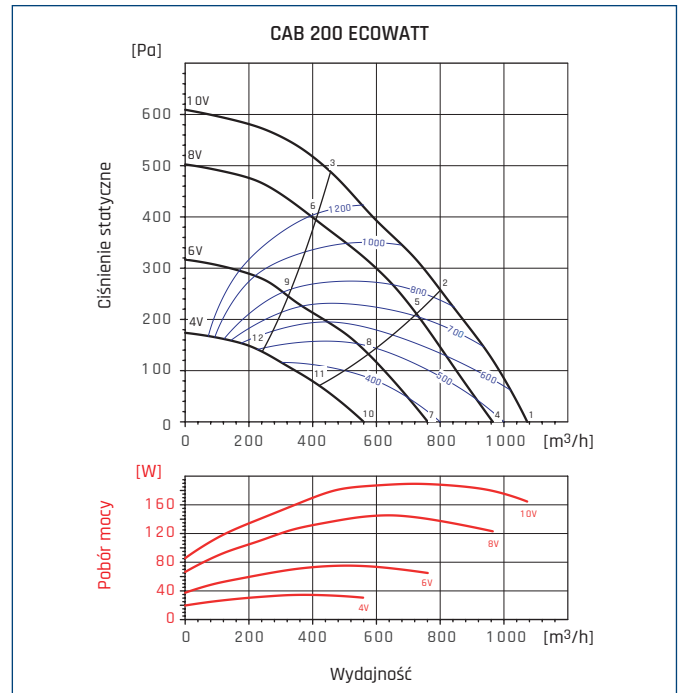
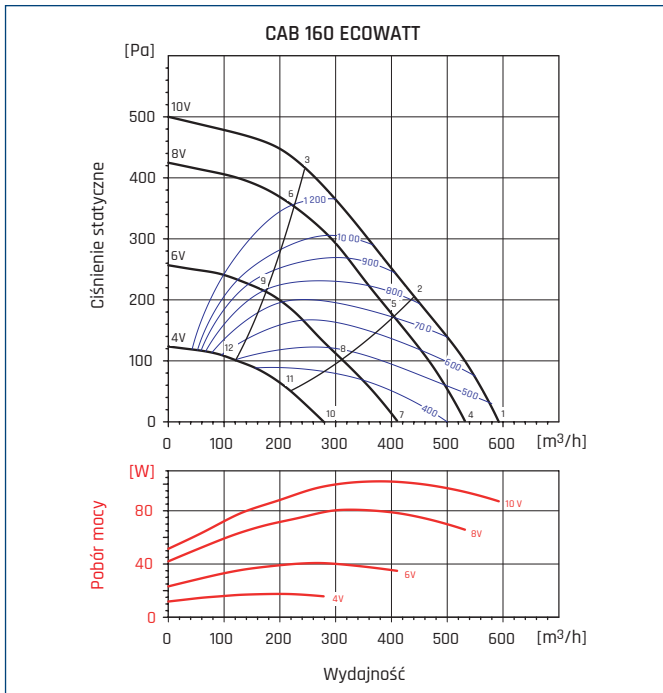

Częst. Hz/dB(A)		63	125	250	500	1000	2000	4000	8000	L <sub>WA</sub>
1	Wlot	41	48	54	62	63	61	57	50	67
	Wylot	44	51	51	52	55	58	55	45	62
	Emitowany	44	46	48	46	50	52	51	42	57
2	Wlot	38	46	54	60	60	57	54	48	65
	Wylot	38	49	48	50	54	56	53	43	60
	Emitowany	41	44	47	44	46	48	48	40	55
3	Wlot	34	45	54	60	59	56	52	48	65
	Wylot	36	47	50	49	53	55	52	45	60
	Emitowany	37	43	48	44	46	47	46	40	54
4	Wlot	39	46	53	59	61	59	55	47	65
	Wylot	41	49	50	49	53	56	53	42	60
	Emitowany	40	45	47	44	49	51	49	40	56
5	Wlot	36	44	53	57	57	55	52	45	63
	Wylot	36	48	48	47	52	54	51	41	59
	Emitowany	38	43	46	42	45	47	46	38	53
6	Wlot	34	44	53	58	57	54	50	45	63
	Wylot	34	46	49	47	51	53	50	43	58
	Emitowany	35	43	46	43	45	46	44	38	53
7	Wlot	32	41	49	53	55	53	48	38	60
	Wylot	32	43	45	42	47	50	46	32	54
	Emitowany	35	41	43	40	43	46	43	33	51
8	Wlot	29	38	47	51	51	49	43	36	56
	Wylot	29	42	44	41	46	49	44	32	53
	Emitowany	32	38	41	38	39	41	38	31	47
9	Wlot	27	37	48	52	51	49	43	37	57
	Wylot	28	44	45	41	45	47	42	34	52
	Emitowany	30	37	42	39	40	41	38	32	48
10	Wlot	25	36	39	45	47	46	33	25	51
	Wylot	25	36	38	34	38	40	31	23	45
	Emitowany	17	29	31	38	39	38	26	18	44
11	Wlot	25	35	38	43	44	42	31	25	48
	Wylot	32	35	34	33	38	39	30	23	44
	Emitowany	18	27	30	35	36	34	23	17	41
12	Wlot	21	35	37	43	43	39	31	25	48
	Wylot	22	37	34	33	38	38	31	24	44
	Emitowany	14	27	30	35	35	32	23	17	40

Częst. Hz/dB(A)		63	125	250	500	1000	2000	4000	8000	L <sub>WA</sub>
1	Wlot	50	53	63	65	68	61	63	60	72
	Wylot	49	57	57	56	60	61	56	50	66
	Emitowany	52	44	49	46	50	47	44	50	58
2	Wlot	44	49	61	61	63	58	62	58	69
	Wylot	43	53	54	53	58	59	55	50	64
	Emitowany	46	40	47	42	45	43	43	48	54
3	Wlot	38	48	66	65	65	59	62	58	71
	Wylot	38	50	57	52	56	60	55	50	64
	Emitowany	40	40	53	46	47	45	42	48	56
4	Wlot	47	50	61	62	65	59	61	57	69
	Wylot	46	54	55	53	58	59	54	46	64
	Emitowany	50	42	47	44	48	45	42	51	56
5	Wlot	42	46	60	59	61	56	59	55	67
	Wylot	41	50	52	51	55	57	53	47	62
	Emitowany	45	38	46	40	44	42	40	49	53
6	Wlot	35	48	64	62	63	57	59	55	69
	Wylot	36	48	55	50	54	58	52	49	62
	Emitowany	38	39	50	44	46	43	40	49	55
7	Wlot	42	44	56	57	59	53	55	46	64
	Wylot	39	48	51	48	52	53	48	36	58
	Emitowany	43	36	44	39	43	39	36	41	50
8	Wlot	36	42	53	54	56	51	53	47	61
	Wylot	35	44	48	46	50	52	49	38	57
	Emitowany	38	34	42	36	40	36	35	41	47
9	Wlot	31	49	56	56	57	51	52	47	62
	Wylot	32	46	49	46	49	52	50	42	57
	Emitowany	32	41	45	38	40	37	34	41	49
10	Wlot	33	39	46	50	51	47	45	35	56
	Wylot	31	40	40	43	46	46	38	27	51
	Emitowany	35	34	38	34	36	34	30	24	43
11	Wlot	29	38	45	49	49	45	44	36	54
	Wylot	29	38	38	41	45	46	37	26	50
	Emitowany	30	32	36	32	33	32	29	25	41
12	Wlot	26	43	48	49	49	43	44	35	55
	Wylot	30	45	42	41	43	46	42	30	51
	Emitowany	28	38	39	33	34	31	28	25	43

## CHARAKTERYSTYKI PRACY I CHARAKTERYSTYKI AKUSTYCZNE

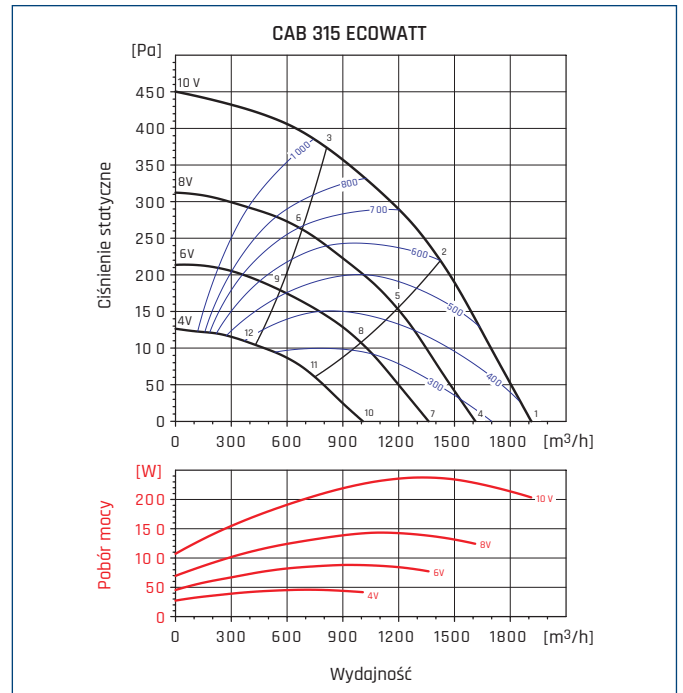
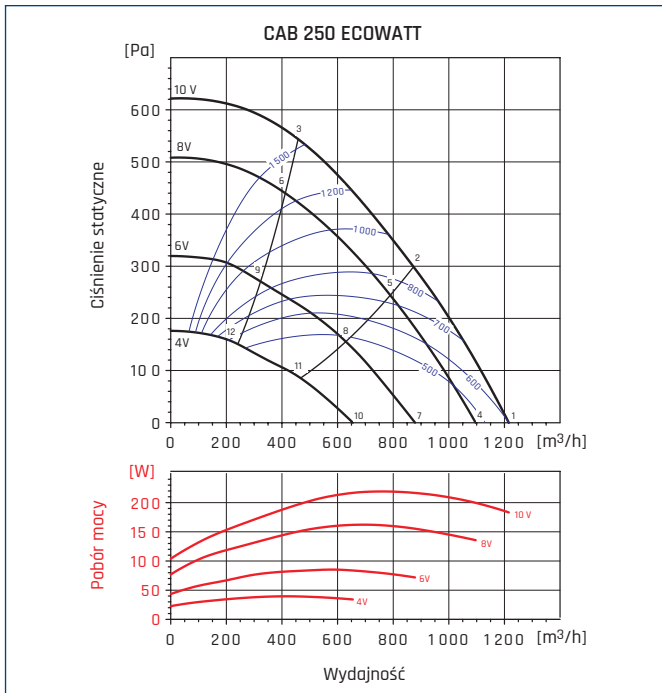

Częst. Hz/dB(A)		63	125	250	500	1000	2000	4000	8000	L <sub>WA</sub>
1	Wlot	54	66	68	71	67	63	58	75	
	Wylot	48	54	60	57	61	64	60	51	68
	Emitowany	40	44	55	50	50	45	37	32	58
2	Wlot	40	52	65	65	66	64	63	58	72
	Wylot	41	51	60	53	58	62	58	51	66
	Emitowany	38	41	55	47	46	42	36	31	56
3	Wlot	38	54	68	67	68	66	64	60	74
	Wylot	40	51	60	55	59	65	60	54	68
	Emitowany	36	44	58	49	47	45	38	33	59
4	Wlot	39	52	64	65	68	64	60	56	72
	Wylot	45	52	58	54	58	62	57	48	66
	Emitowany	37	44	53	48	49	44	36	31	56
5	Wlot	38	50	62	63	64	62	60	55	69
	Wylot	40	49	57	50	55	60	55	48	64
	Emitowany	35	42	52	46	44	42	36	30	54
6	Wlot	36	54	65	64	65	64	62	57	71
	Wylot	38	50	58	52	56	63	57	51	66
	Emitowany	33	45	54	47	45	44	37	32	56
7	Wlot	36	49	59	59	63	59	53	49	67
	Wylot	39	48	56	48	52	56	50	41	61
	Emitowany	33	42	49	43	44	39	31	27	52
8	Wlot	33	47	58	57	58	56	53	48	64
	Wylot	34	45	54	46	51	55	48	41	59
	Emitowany	30	40	48	41	39	37	31	26	50
9	Wlot	32	52	58	58	59	58	54	49	65
	Wylot	33	48	52	46	51	57	50	43	60
	Emitowany	29	45	49	42	40	39	32	27	51
10	Wlot	29	45	49	52	55	52	45	38	59
	Wylot	32	44	41	40	44	49	41	32	52
	Emitowany	28	40	38	35	36	33	29	25	44
11	Wlot	28	47	48	50	51	49	43	38	56
	Wylot	30	44	41	41	45	48	39	32	52
	Emitowany	27	41	37	33	32	31	28	25	44
12	Wlot	27	47	49	51	52	50	45	38	57
	Wylot	31	46	42	43	47	49	40	33	53
	Emitowany	26	42	38	34	32	32	29	26	45

Częst. Hz/dB(A)		63	125	250	500	1000	2000	4000	8000	L <sub>WA</sub>
1	Wlot	54	67	67	66	63	59	57	72	
	Wylot	47	57	66	59	64	60	53	46	69
	Emitowany	42	48	65	54	57	54	49	46	66
2	Wlot	41	54	67	66	64	59	56	53	71
	Wylot	43	55	65	56	62	58	51	44	68
	Emitowany	42	48	65	53	55	50	46	42	66
3	Wlot	41	58	67	66	64	58	55	51	71
	Wylot	41	53	63	56	62	60	56	48	68
	Emitowany	42	52	65	53	54	49	45	40	66
4	Wlot	39	53	62	63	63	58	53	54	68
	Wylot	43	55	62	55	59	56	48	42	65
	Emitowany	40	46	59	49	53	53	43	41	61
5	Wlot	40	54	64	61	59	53	49	49	67
	Wylot	41	53	61	52	58	53	45	38	64
	Emitowany	40	47	61	47	50	48	39	36	62
6	Wlot	38	58	62	61	59	54	49	45	67
	Wylot	39	51	58	52	58	56	51	40	63
	Emitowany	38	51	59	47	50	49	39	31	60
7	Wlot	39	54	57	59	59	53	49	50	64
	Wylot	41	56	52	50	57	51	43	40	61
	Emitowany	39	50	50	45	51	44	38	36	56
8	Wlot	37	55	54	57	55	48	45	40	62
	Wylot	38	54	49	47	55	48	40	36	59
	Emitowany	37	51	47	43	48	39	34	26	54
9	Wlot	35	57	54	57	55	49	44	39	62
	Wylot	35	52	48	47	56	50	42	35	59
	Emitowany	35	52	47	43	48	40	33	25	55
10	Wlot	35	48	50	55	52	43	46	31	58
	Wylot	37	49	46	46	49	43	40	30	54
	Emitowany	37	45	44	43	48	37	36	24	52
11	Wlot	32	46	48	54	48	41	37	29	56
	Wylot	34	46	42	47	47	41	34	30	52
	Emitowany	33	42	41	42	45	34	27	22	49
12	Wlot	33	48	49	55	49	41	36	30	58
	Wylot	33	45	42	46	47	42	31	29	52
	Emitowany	34	44	42	43	46	35	26	23	50

## CHARAKTERYSTYKI PRACY I CHARAKTERYSTYKI AKUSTYCZNE

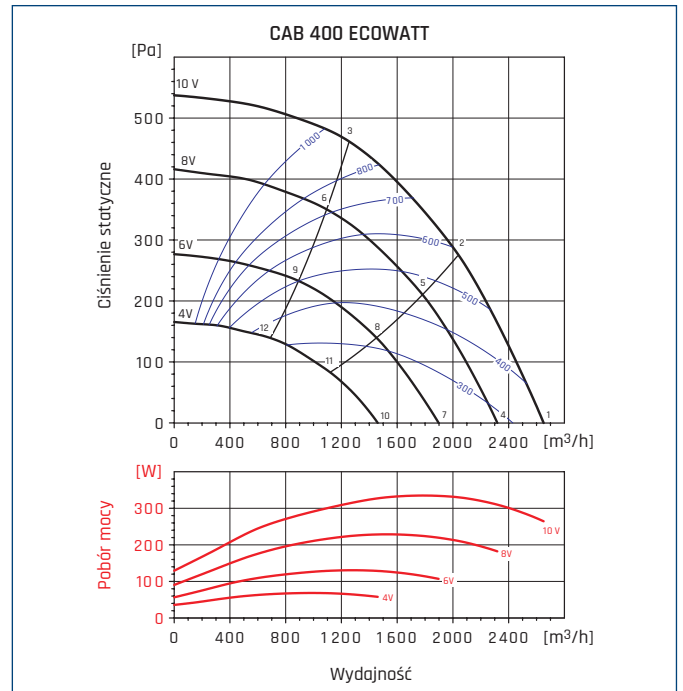
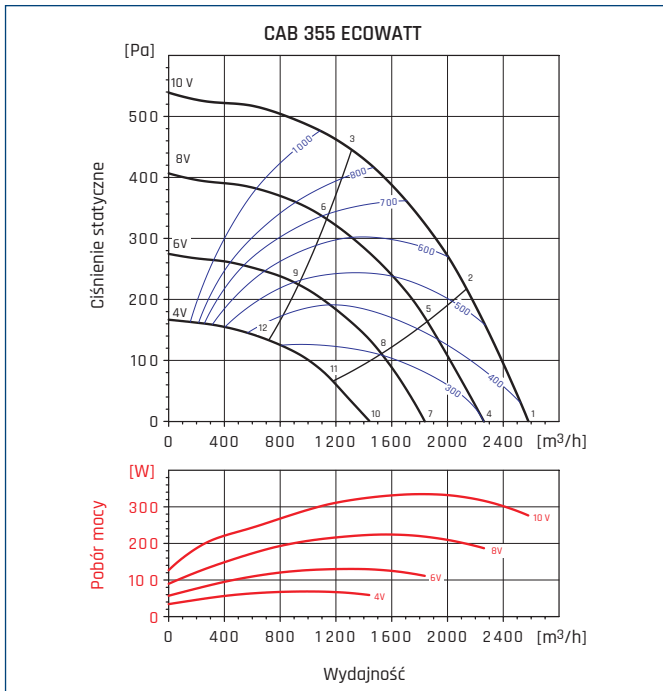

Częst. Hz/dB(A)		63	125	250	500	1000	2000	4000	8000	L <sub>WA</sub>
1	Wlot	46	58	67	67	67	66	64	63	74
	Wylot	52	59	63	62	66	62	55	49	70
	Emitowany	41	49	62	53	55	53	48	49	64
2	Wlot	42	55	67	66	66	63	60	59	72
	Wylot	45	55	63	59	63	60	52	46	68
	Emitowany	37	46	61	52	54	51	45	45	63
3	Wlot	39	58	65	64	63	60	58	55	70
	Wylot	41	55	61	56	61	58	51	46	66
	Emitowany	34	48	60	50	51	47	42	41	61
4	Wlot	41	58	64	64	65	63	58	61	71
	Wylot	48	56	62	58	63	59	51	46	67
	Emitowany	36	49	59	49	53	51	42	48	61
5	Wlot	37	55	64	62	63	58	55	56	69
	Wylot	41	53	63	54	61	56	48	42	66
	Emitowany	32	46	59	47	51	46	38	42	60
6	Wlot	37	61	61	60	58	52	52	48	67
	Wylot	38	53	61	51	59	54	47	41	64
	Emitowany	32	52	56	45	46	40	36	35	58
7	Wlot	37	58	57	60	65	58	54	57	68
	Wylot	42	58	52	52	63	53	46	42	65
	Emitowany	34	50	47	44	50	45	38	44	56
8	Wlot	33	58	55	58	60	51	50	50	64
	Wylot	37	56	49	49	63	51	42	37	64
	Emitowany	30	51	45	42	45	38	34	37	53
9	Wlot	34	56	53	56	57	48	47	42	62
	Wylot	35	54	47	46	63	49	41	34	63
	Emitowany	29	50	44	40	49	35	31	29	53
10	Wlot	32	51	52	55	56	49	52	38	61
	Wylot	36	52	46	47	52	47	43	30	57
	Emitowany	30	43	42	46	45	37	39	30	51
11	Wlot	29	49	50	52	50	43	46	33	57
	Wylot	33	49	43	45	51	44	38	26	54
	Emitowany	27	41	40	43	39	31	33	25	47
12	Wlot	28	47	47	50	47	40	39	33	54
	Wylot	31	45	41	42	50	41	33	26	52
	Emitowany	26	39	37	41	36	28	26	25	45

Częst. Hz/dB(A)		63	125	250	500	1000	2000	4000	8000	L <sub>WA</sub>
1	Wlot	46	58	65	67	65	66	61	57	72
	Wylot	46	59	64	63	67	63	56	49	71
	Emitowany	44	50	62	56	58	58	51	47	65
2	Wlot	40	54	63	64	62	60	53	51	69
	Wylot	41	54	63	59	64	60	52	46	68
	Emitowany	38	46	60	53	55	52	44	41	62
3	Wlot	41	58	64	63	58	54	51	47	68
	Wylot	41	57	61	58	62	58	53	47	67
	Emitowany	39	50	61	52	51	46	41	38	62
4	Wlot	39	53	62	63	63	58	53	54	68
	Wylot	43	55	62	55	59	56	48	42	65
	Emitowany	40	46	59	49	53	53	43	41	61
5	Wlot	40	54	64	61	59	53	49	49	67
	Wylot	41	53	61	52	58	53	45	38	64
	Emitowany	40	47	61	47	50	48	39	36	62
6	Wlot	38	58	62	61	59	54	49	45	67
	Wylot	39	51	58	52	58	56	51	40	63
	Emitowany	38	51	59	47	50	49	39	31	60
7	Wlot	39	54	57	59	59	53	49	50	64
	Wylot	41	56	52	50	57	51	43	40	61
	Emitowany	39	50	50	45	51	44	38	36	56
8	Wlot	37	55	54	57	55	48	45	40	62
	Wylot	38	54	49	47	55	48	40	36	59
	Emitowany	37	51	47	43	48	39	34	26	54
9	Wlot	35	57	54	57	55	49	44	39	62
	Wylot	35	52	48	47	56	50	42	35	59
	Emitowany	35	52	47	43	48	40	33	25	55
10	Wlot	35	48	50	55	52	43	46	31	58
	Wylot	37	49	46	46	49	43	40	30	54
	Emitowany	37	45	44	43	48	37	36	24	52
11	Wlot	32	46	48	54	48	41	37	29	56
	Wylot	34	46	42	47	47	41	34	30	52
	Emitowany	33	42	41	42	45	34	27	22	49
12	Wlot	33	48	49	55	49	41	36	30	58
	Wylot	33	45	42	46	47	42	31	29	52
	Emitowany	34	44	42	43	46	35	26	23	50

## WYMIARY [mm]

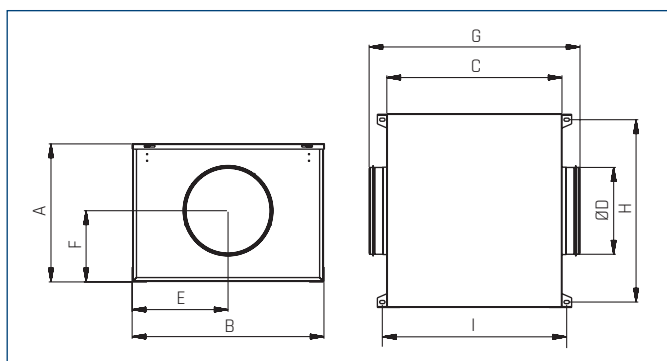

Typ	A	B	C	ØD	E	F	G	H	I
CAB-125 ECOWATT	316	420	386	125	210	163	433	389	412
CAB-150 ECOWATT	334	447	415	150	224	174	517	416	441
CAB-160 ECOWATT	334	447	415	160	224	174	517	416	441
CAB-200 ECOWATT	375	510	468	200	255	193	570	479	494
CAB-250 ECOWATT	395	553	505	250	277	204	608	522	535
CAB-315 ECOWATT	441	609	555	315	305	221	659	585	580
CAB-355 ECOWATT	501	699	578	355	350	251	682	668	606
CAB-400 ECOWATT	501	699	578	400	350	251	682	668	606

## AKCESORIA MONTAŻOWE

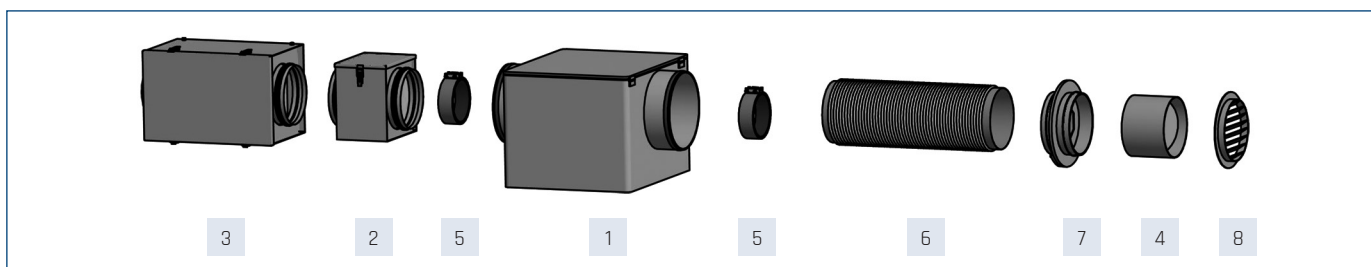

Wentylator	1	2 filtr kanałowy DF	3 filtr kanałowy DF-K				
			wkład filtracyjny do DF-K				
			EU3	EU5	EU7	EU9	
CAB-125 ECOWATT		DF 125	DF-K 125	EU3   100-250mm	EU5   100-250mm	EU7   100-250mm	EU9   100-250mm
CAB-150 ECOWATT		DF 160*	DF-K 160*	EU3   100-250mm*	EU5   100-250mm*	EU7   100-250mm*	EU9   100-250mm*
CAB-160 ECOWATT		DF 160	DF-K 160	EU3   100-250mm	EU5   100-250mm	EU7   100-250mm	EU9   100-250mm
CAB-200 ECOWATT		DF 200	DF-K 200	EU3   100-250mm	EU5   100-250mm	EU7   100-250mm	EU9   100-250mm
CAB-250 ECOWATT		DF 250	DF-K 250	EU3   100-250mm	EU5   100-250mm	EU7   100-250mm	EU9   100-250mm
CAB-315 ECOWATT		DF 315	DF-K 315	EU3   315-450mm	EU5   315-450mm	EU7   315-450mm	-
CAB-355 ECOWATT		DF 355	DF-K 355	EU3   315-450mm	EU5   315-450mm	EU7   315-450mm	-
CAB-400 ECOWATT		DF 400	DF-K 400	EU3   315-450mm	EU5   315-450mm	EU7   315-450mm	-

Wentylator	1	4 klapa zwrotna CAR-PL	5 złącze przeciwdrgan. ACOP PL	6 tłumik akustyczny AKU COMP		7 przepustnica soczewk. IRIS	8 kratka wentylacyjna KWO
				0,6m	1,2m		
				CAB-125 ECOWATT			
CAB-150 ECOWATT		CAR-PL 150	ACOP PL 150	AKU-COMP 160/0.6*	AKU-COMP 160/1.2*	IRIS 160*	KWO 160*
CAB-160 ECOWATT		CAR-PL 160	ACOP PL 160	AKU-COMP 160/0.6	AKU-COMP 160/1.2	IRIS 160	KWO 160
CAB-200 ECOWATT		CAR-PL 200	ACOP PL 200	AKU-COMP 200/0.6	AKU-COMP 200/1.2	IRIS 200	KWO 200
CAB-250 ECOWATT		CAR-PL 250	ACOP PL 250	AKU-COMP 250/0.6	AKU-COMP 250/1.2	IRIS 250	KWO 250
CAB-315 ECOWATT		CAR-PL 315	ACOP PL 315	AKU-COMP 315/0.6	AKU-COMP 315/1.2	IRIS 315	KWO 315
CAB-355 ECOWATT		CAR-PL 355	ACOP PL 355	-	-	-	-
CAB-400 ECOWATT		CAR-PL 400	ACOP PL 400	-	-	IRIS 400	KWO 400

\*akcesoria montażowe dedykowane do średnicy 160 mm

## Numer y artykułów

ACOP PL 125	40521815	AKU-COMP 200/0.6	40521540	CAR-PL 355	40521065-01	DF-K 250	40521730	IRIS 160	19527160
ACOP PL 150	40521818	AKU-COMP 200/1.2	40521640	CAR-PL 400	40521070-01	DF-K 315	40521735	IRIS 200	19527200
ACOP PL 160	40521820	AKU-COMP 250/0.6	40521550	DF 125	40520620	DF-K 355	40521740	IRIS 250	19527250
ACOP PL 200	40521825	AKU-COMP 250/1.2	40521650	DF 160	40520630	DF-K 400	40521745	IRIS 315	19527315
ACOP PL 250	40521830	AKU-COMP 315/0.6	40521560	DF 200	40520640	EU3   100-250mm	40520800	IRIS 400	19527400
ACOP PL 315	40521835	AKU-COMP 315/1.2	40521660	DF 250	40520650	EU3   315-450mm	40520830	KWO 125	40522530
ACOP PL 355	40521840	CAR-PL 125	40521020-01	DF 315	40520660	EU5   100-250mm	40520805	KWO 160	40522540
ACOP PL 400	40521845	CAR-PL 150	40521029-01	DF 355	40520670	EU5   315-450mm	40520835	KWO 200	40522550
AKU-COMP 125/0.6	40521520	CAR-PL 160	40521030-01	DF 400	40520675	EU7   100-250mm	40520810	KWO 250	40522560
AKU-COMP 125/1.2	40521620	CAR-PL 200	40521040-01	DF-K 125	40521715	EU7   315-450mm	40520840	KWO 315	40522570
AKU-COMP 160/0.6	40521530	CAR-PL 250	40521050-01	DF-K 160	40521720	EU9   100-250mm	40520820	KWO 400	40522580
AKU-COMP 160/1.2	40521630	CAR-PL 315	40521060-01	DF-K 200	40521725	IRIS 125	19527125		

## AKCESORIA MONTAŻOWE

								
filtr <b>DF</b> str. 243	zest. filtr. <b>DFK...+EU</b> str. 244	kłapa zwrotna <b>CAR-PL</b> str. 247	złącze p-drg. <b>ACOP-PL</b> str. 246	tłumik <b>AKU-COMP</b> str. 241	przepustnica <b>IRIS</b> str. 248	kratka <b>KWO</b> str. 661	anemostat <b>AKT/AKK</b> str. 658	nagrzewnica <b>DH/DH-R</b> str. 233

## AKCESORIA ELEKTRYCZNE

Wentylator	termostat ścienny	termostat kanałowy	czujnik zanieczyszczeń	higrostat	regulator
	TS	TK-1	SQA	HIG-2	REB-ECOWATT
CAB-125 ECOWATT	TS	TK-1	SQA	HIG-2	REB-ECOWATT
CAB-150 ECOWATT	TS	TK-1	SQA	HIG-2	REB-ECOWATT
CAB-160 ECOWATT	TS	TK-1	SQA	HIG-2	REB-ECOWATT
CAB-200 ECOWATT	TS	TK-1	SQA	HIG-2	REB-ECOWATT
CAB-250 ECOWATT	TS	TK-1	SQA	HIG-2	REB-ECOWATT
CAB-315 ECOWATT	TS	TK-1	SQA	HIG-2	REB-ECOWATT
CAB-355 ECOWATT	TS	TK-1	SQA	HIG-2	REB-ECOWATT
CAB-400 ECOWATT	TS	TK-1	SQA	HIG-2	REB-ECOWATT

## Numery artykułów

HIG-2	40025150	REB-ECOWATT	40025005	SQA	40025140	TK-1	40025330	TS	40025345
-------	----------	-------------	----------	-----	----------	------	----------	----	----------

				
termostat <b>TS</b> str. 650	termostat <b>TK-1</b> str. 650	czujnik <b>SQA</b> str. 645	higrostat <b>HIG-2</b> str. 645	regulator <b>REB ECOWATT</b> str. 638

## CHARAKTERYSTYKA ERP

SWNM*					
	Nazwa produktu	CAB-125 ECOWATT	CAB-150 ECOWATT	CAB-160 ECOWATT	CAB-200 ECOWATT
a	Nazwa dostawcy	VENTURE INDUSTRIES / SOLER&PALAU	VENTURE INDUSTRIES / SOLER&PALAU	VENTURE INDUSTRIES / SOLER&PALAU	VENTURE INDUSTRIES / SOLER&PALAU
b	Numer artykułu	41020460	41020461	41020462	41020463
c	Kategoria urządzenia	SWNM (NRVU)	SWNM (NRVU)	SWNM (NRVU)	SWNM (NRVU)
c	Typ urządzenia	JSW (UVU)	JSW (UVU)	JSW (UVU)	JSW (UVU)
d	Napęd	bezstopniowy	bezstopniowy	bezstopniowy	bezstopniowy
e	Typ odzysku ciepła	nie dotyczy	nie dotyczy	nie dotyczy	nie dotyczy
f	Sprawność temperaturowa [%]	nie dotyczy	nie dotyczy	nie dotyczy	nie dotyczy
g	Znamionowe natężenie przepływu w SWNM w [m <sup>3</sup> /s]	0,06	0,07	0,08	0,17
h	Efektywny pobór mocy w (kW)	0,05	0,1	0,09	0,19
i	JMWint w W/(m <sup>3</sup> /s)	nie dotyczy	nie dotyczy	nie dotyczy	nie dotyczy
j	Prędkość czołowa w m/s	0,66	0,71	0,75	1,19
k	$\Delta p_{s, ext}$ (Pa)	217,1	410	303,1	394,7
l	$\Delta p_{s, int}$ (Pa)	nie dotyczy	nie dotyczy	nie dotyczy	nie dotyczy
m	$\Delta p_{s, add}$ (Pa)	nie dotyczy	nie dotyczy	nie dotyczy	nie dotyczy
n	sprawność statyczna wentylatora [%]	39,2	40,9	40,9	50,23
o	Stopień zewnętrznych przecieków powietrza [%]	3	3	3	3
p	Stopień wewnętrznych przecieków powietrza [%]	nie dotyczy	nie dotyczy	nie dotyczy	nie dotyczy
q	efektywność energetyczna filtra	nie dotyczy	nie dotyczy	nie dotyczy	nie dotyczy
r	Ostrzeżenia o konieczności wymiany filtra	nie dotyczy	nie dotyczy	nie dotyczy	nie dotyczy
s	$L_{wa}$ dB(A)				
	Strona internetowa	www.venture.pl www.solerpalau.com	www.venture.pl www.solerpalau.com	www.venture.pl www.solerpalau.com	www.venture.pl www.solerpalau.com
	Nazwa produktu	CAB-250 ECOWATT	CAB-315 ECOWATT	CAB-355 ECOWATT	CAB-400 ECOWATT
a	Nazwa dostawcy	VENTURE INDUSTRIES / SOLER&PALAU	VENTURE INDUSTRIES / SOLER&PALAU	VENTURE INDUSTRIES / SOLER&PALAU	VENTURE INDUSTRIES / SOLER&PALAU
b	Numer artykułu	41020464	41020465	41020466	41020467
c	Kategoria urządzenia	SWNM (NRVU)	SWNM (NRVU)	SWNM (NRVU)	SWNM (NRVU)
c	Typ urządzenia	JSW (UVU)	JSW (UVU)	JSW (UVU)	JSW (UVU)
d	Napęd	bezstopniowy	bezstopniowy	bezstopniowy	bezstopniowy
e	Typ odzysku ciepła	nie dotyczy	nie dotyczy	nie dotyczy	nie dotyczy
f	Sprawność temperaturowa [%]	nie dotyczy	nie dotyczy	nie dotyczy	nie dotyczy
g	Znamionowe natężenie przepływu w SWNM w [m <sup>3</sup> /s]	0,18	0,3	0,42	0,42
h	Efektywny pobór mocy w (kW)	0,22	0,23	0,33	0,33
i	JMWint w W/(m <sup>3</sup> /s)	nie dotyczy	nie dotyczy	nie dotyczy	nie dotyczy
j	Prędkość czołowa w m/s	1,08	1,46	1,5	1,51
k	$\Delta p_{s, ext}$ (Pa)	454	317,9	407,3	413,8
l	$\Delta p_{s, int}$ (Pa)	nie dotyczy	nie dotyczy	nie dotyczy	nie dotyczy
m	$\Delta p_{s, add}$ (Pa)	nie dotyczy	nie dotyczy	nie dotyczy	nie dotyczy
n	sprawność statyczna wentylatora [%]	56,8	64,2	68,1	68,1
o	Stopień zewnętrznych przecieków powietrza [%]	3	3	3	3
p	Stopień wewnętrznych przecieków powietrza [%]	nie dotyczy	nie dotyczy	nie dotyczy	nie dotyczy
q	efektywność energetyczna filtra	nie dotyczy	nie dotyczy	nie dotyczy	nie dotyczy
r	Ostrzeżenia o konieczności wymiany filtra	nie dotyczy	nie dotyczy	nie dotyczy	nie dotyczy
s	$L_{wa}$ dB(A)				
	Strona internetowa	www.venture.pl www.solerpalau.com	www.venture.pl www.solerpalau.com	www.venture.pl www.solerpalau.com	www.venture.pl www.solerpalau.com

\* SWNM-"system wentylacyjny przeznaczony do budynków niemieszkalnych"-zgodnie z Rozporządzeniem Komisji (UE) nr 1253/2014